

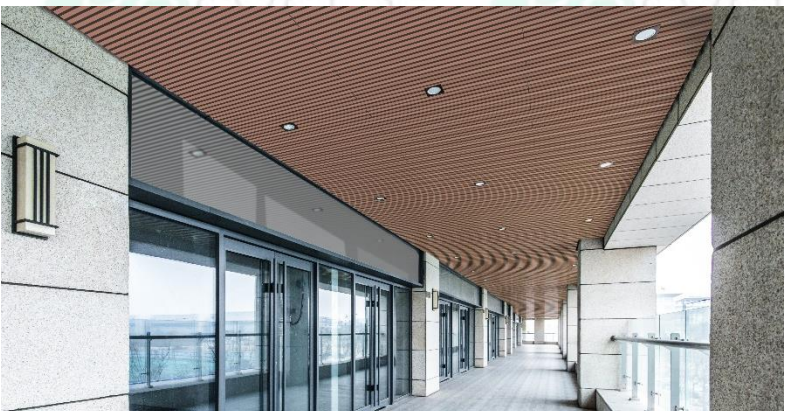

INSTALLATION GUIDE

RESYSTA LUSSO CLADDING (RESLP340612)

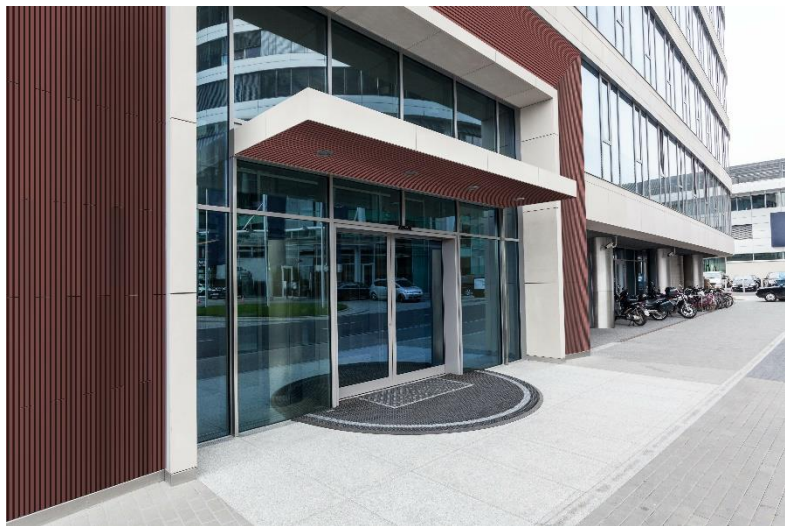

1. Introduction

1.1 Material Components

1.2 Basics

1.3 Scope of Profiles

2. Installation Guide

3. General Guidelines

3.1 Walls higher than

12' long

3.2 Expansion Joint

3.3 General Note

3.4 Disclaimer

1. Introduction

Resysta is an extremely durable, timber look-alike, building material. It is resistant to damage from the sun, rain, snow and even salt water. Unlike wood, it requires minimal maintenance and is highly resistant to pests, mold and cracks. Unlike other composite materials, it closely resembles the look and feel of natural wood, with a smooth surface finish. Resysta meets most of the future environmentally sustainable material requirements concerning recycled and fully recyclable materials. Resysta is used for its architectural aesthetic, and not for structural support.

1.1 Material Components

A combination of these three basic raw materials make up the simple components that create Resysta. This innovative material offers designers and architects new creative horizons to utilize its compelling and unique appearance.



Approx. 60% RICE HUSK + Approx. 22% COMMON SALT + Approx. 18% MINERAL OIL

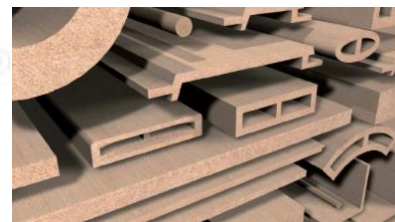



= RESYSTA PRODUCT

1.2 Basics

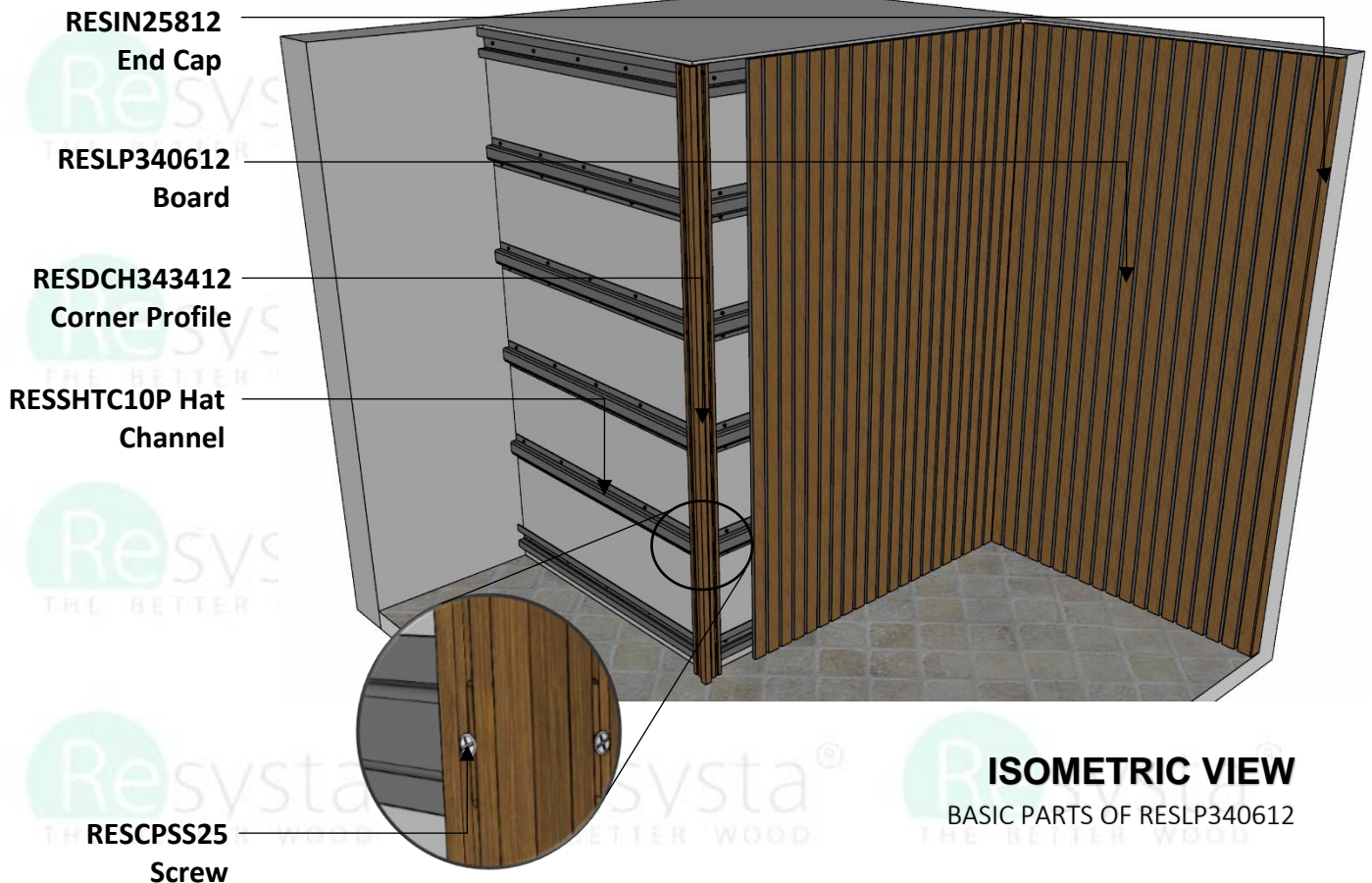
OVERVIEW OF PARTS

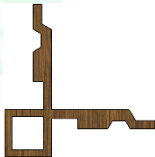

1.3 Scope of Profiles

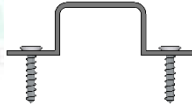
NO.	PRODUCT NAME AND SPECIFICATION	ISOMETRIC VIEW	FRONT VIEW
1	RESLP340612 $\frac{3}{4}$ " x 5 $\frac{3}{4}$ " x 12' Lusso Hollow Cladding Profile		
2	RESDCH343412 $\frac{3}{4}$ " x $\frac{3}{4}$ " x 12' Corner Profile		
3	RESSHTC10P Aluminium Hat Channel Runner		
4	RESCPSS25 TEC Shoulder Sliding Screw		

NOTE: Table above shows products commonly used for wall cladding. To view a complete list of products, please refer to our Resysta brochure or visit our web site <https://www.resystausa.com/>

2. Installation Guide

PROCEDURES:

- 2.1 Check the layout and designed direction of the Lusso cladding to be installed; whether it is horizontal, vertical or depends on the design requirements. Also check the layout for existing plumbing and electrical wiring to make sure that there is not any interference.
- 2.2 Check the surface wall level to be 100% levelled before installing the aluminium Runner RESSHTC10P.

2.3 Establish gridline for the aluminum hat channel RESSHTC10P, minimum of 2 ½" from finish ceiling line to center of first hat channel and followed by minimum 16" spacing center to center hat channel. The last hat channel needs to have a maximum 4 ½" from finish floor line to center of hat channel.

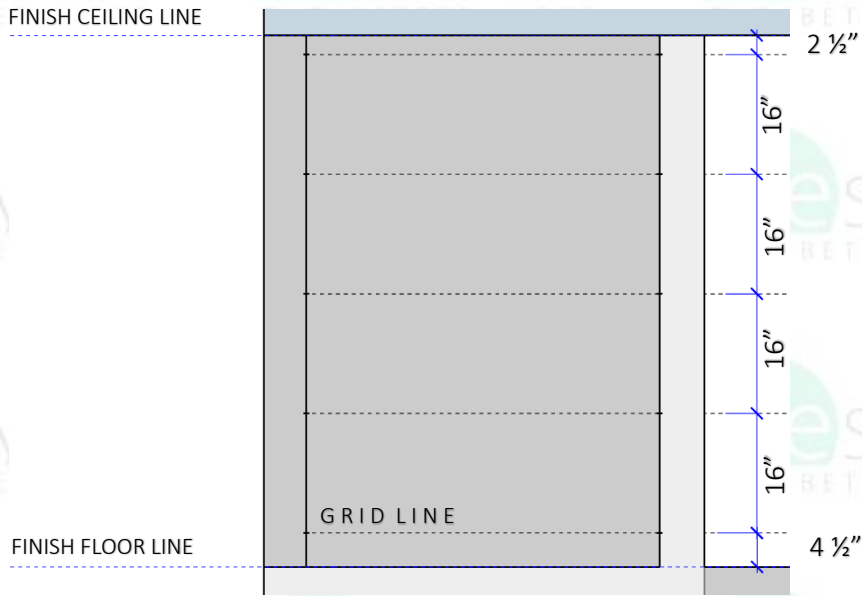

FRONT ELEVATION

2.4 Install the first horizontal hat channel on a reverse orientation starting from the finish ceiling line to the center of hat channel with a minimum 2 ½" and followed by minimum of 16" center to center. Note that the last hat channel needs to have a maximum 4 ½" from finish floor line to center of hat channel.

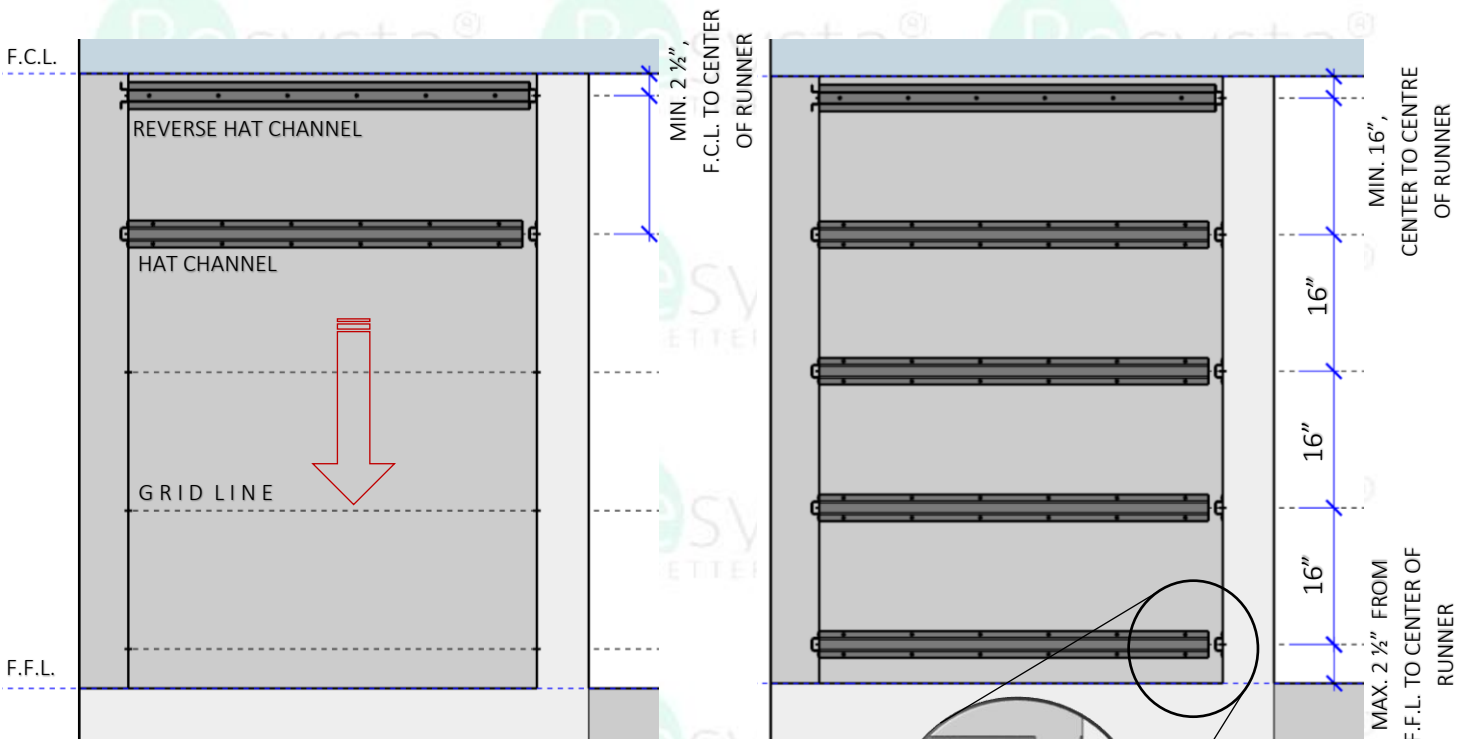

FRONT ELEVATION

2.5 Screw the RESDCH343412 corner profile directly into the hat channel using RESCPSS25 screw and make sure that the corner is plumb.

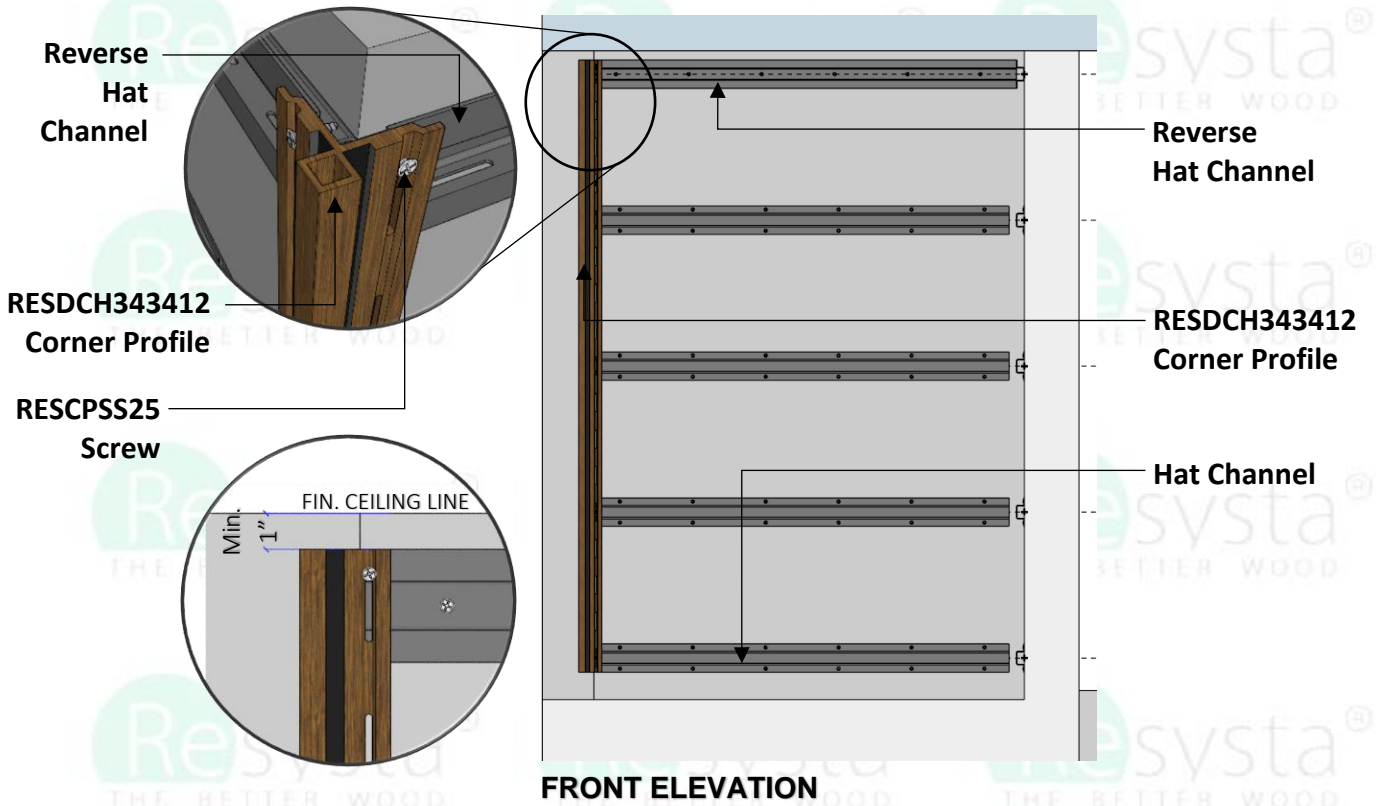

2.6 Slide and screw in the first RESLP340612 aligned into the hat channel and make sure that the corner is plumb.

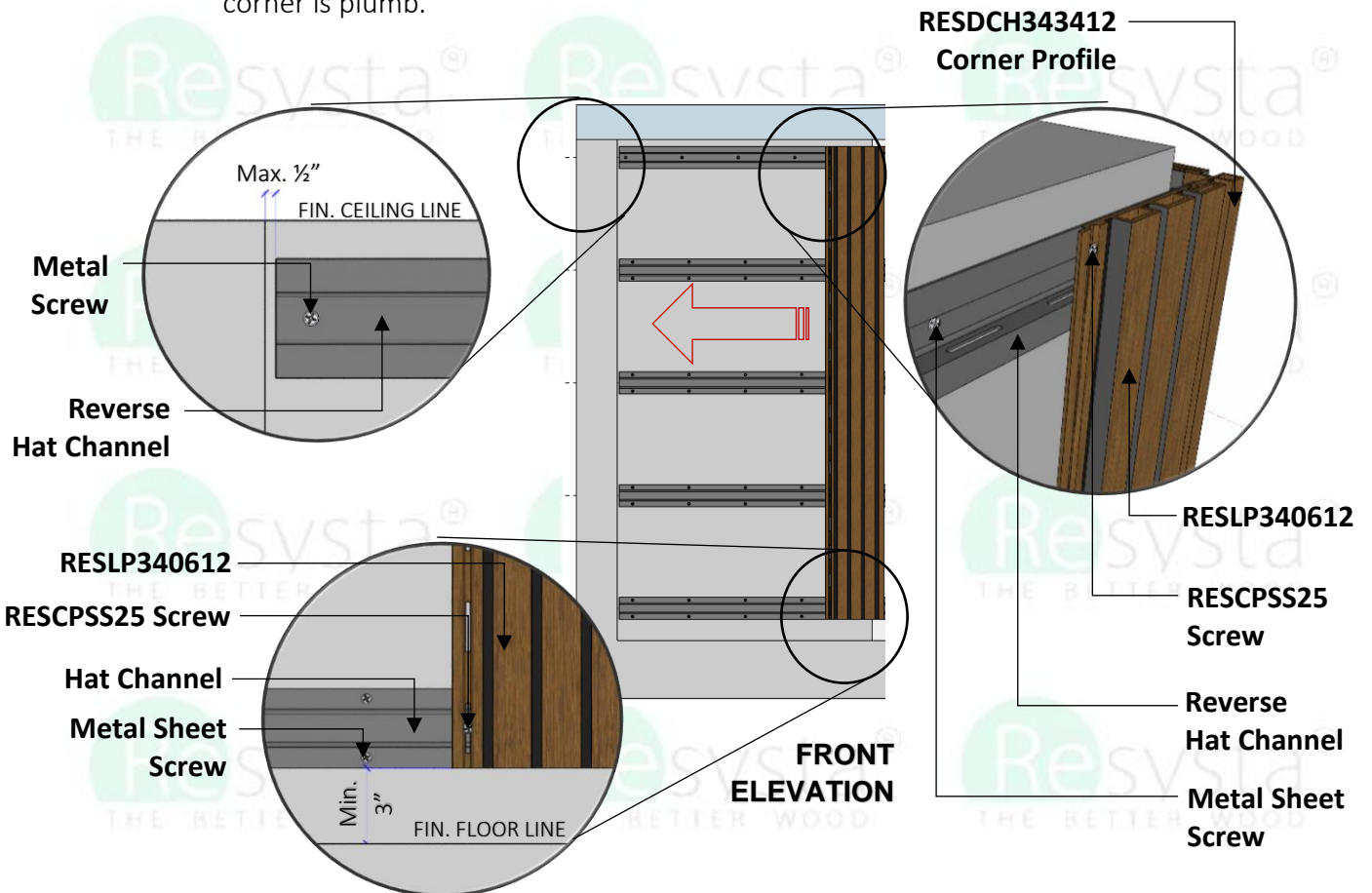

2.7 Repeat horizontally the installation of RESLP340612 direct into the hat channel until reaching the end of the wall and make sure that the corner is plumb.

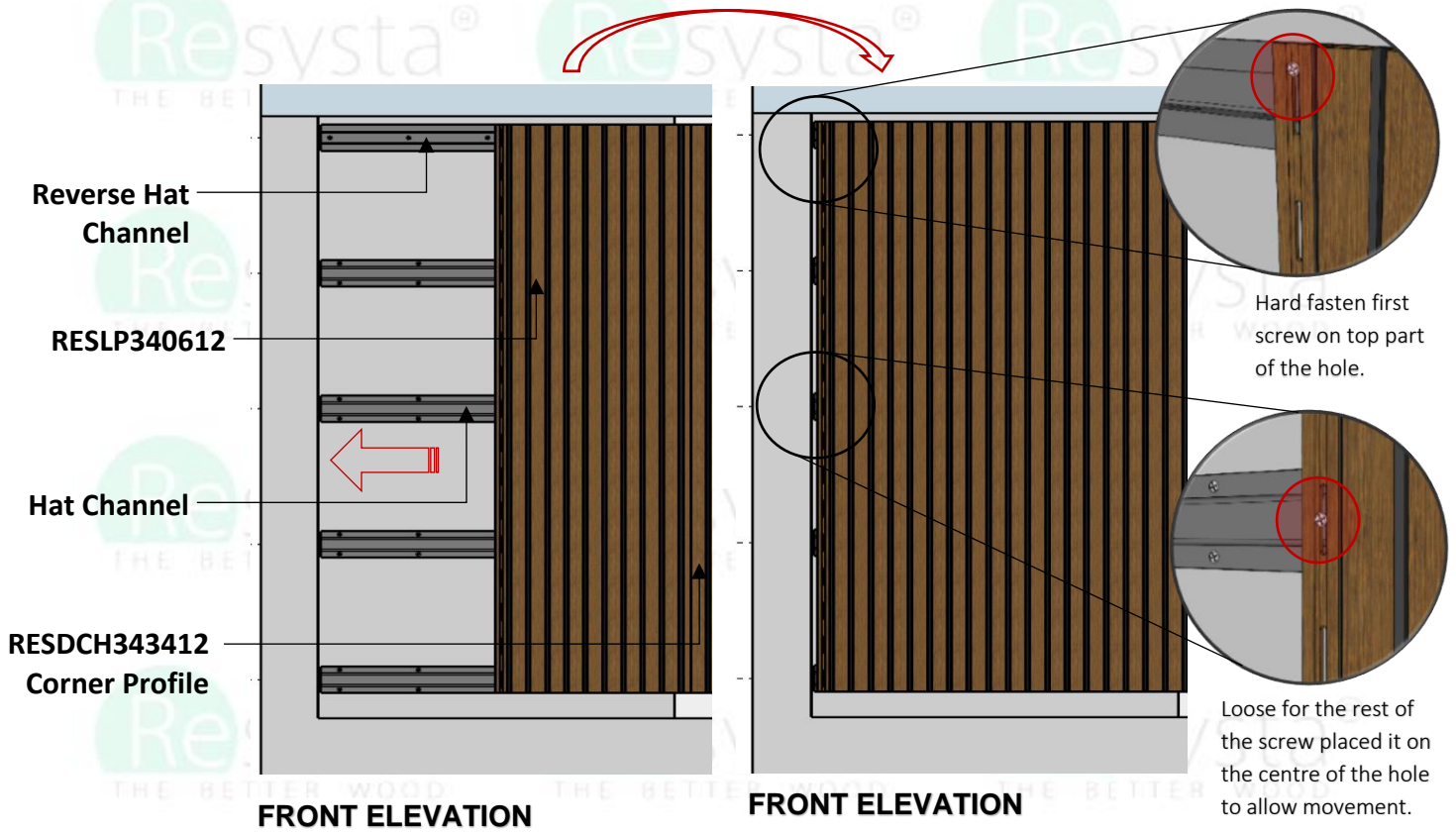

2.8 The last board needs to be cut and glued to the previous board tongue using PL Premium adhesive.

OPTION 01 Cutting the male part RESLP340612
(BOARD ENDING PERPENDICULAR INTO A WALL)

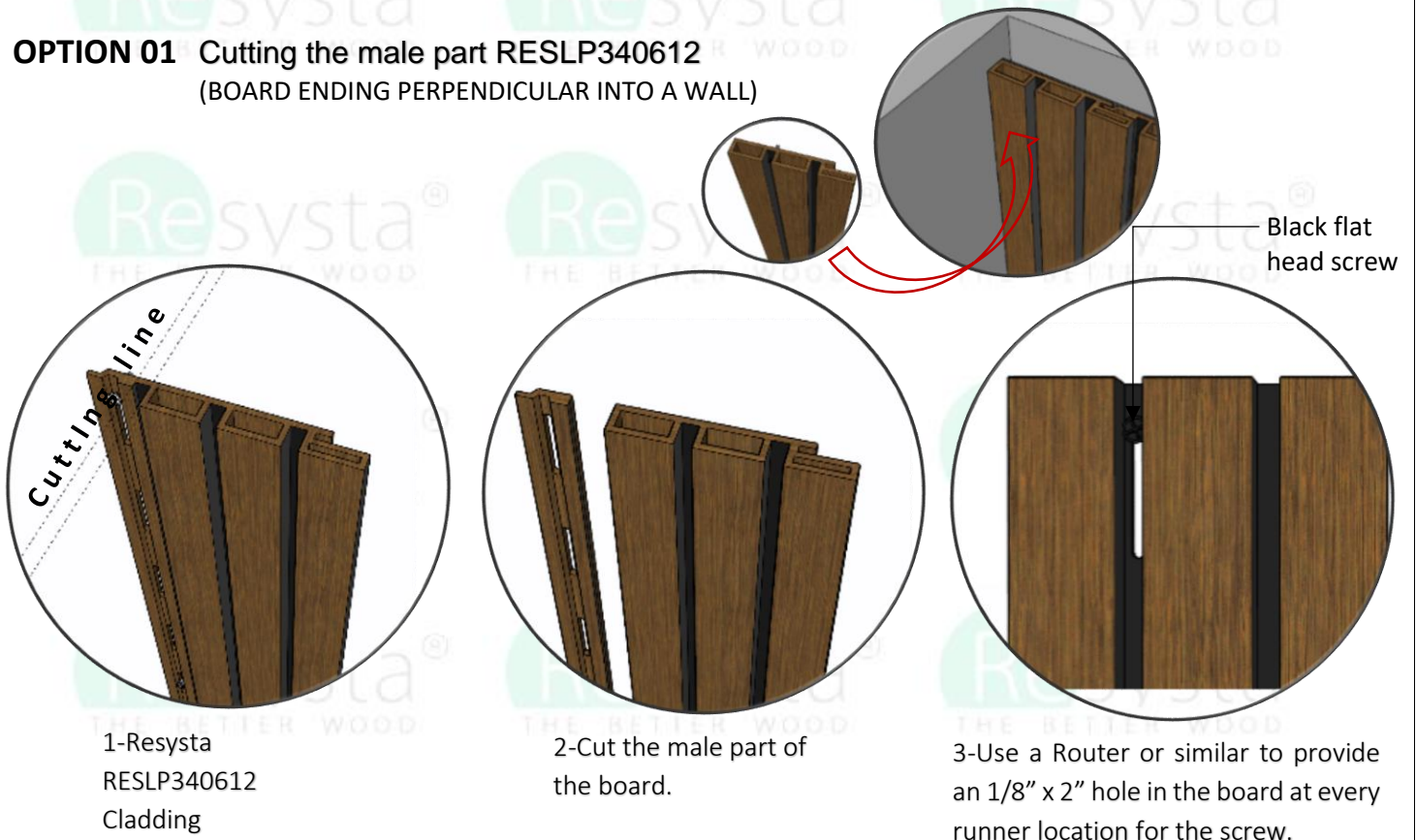

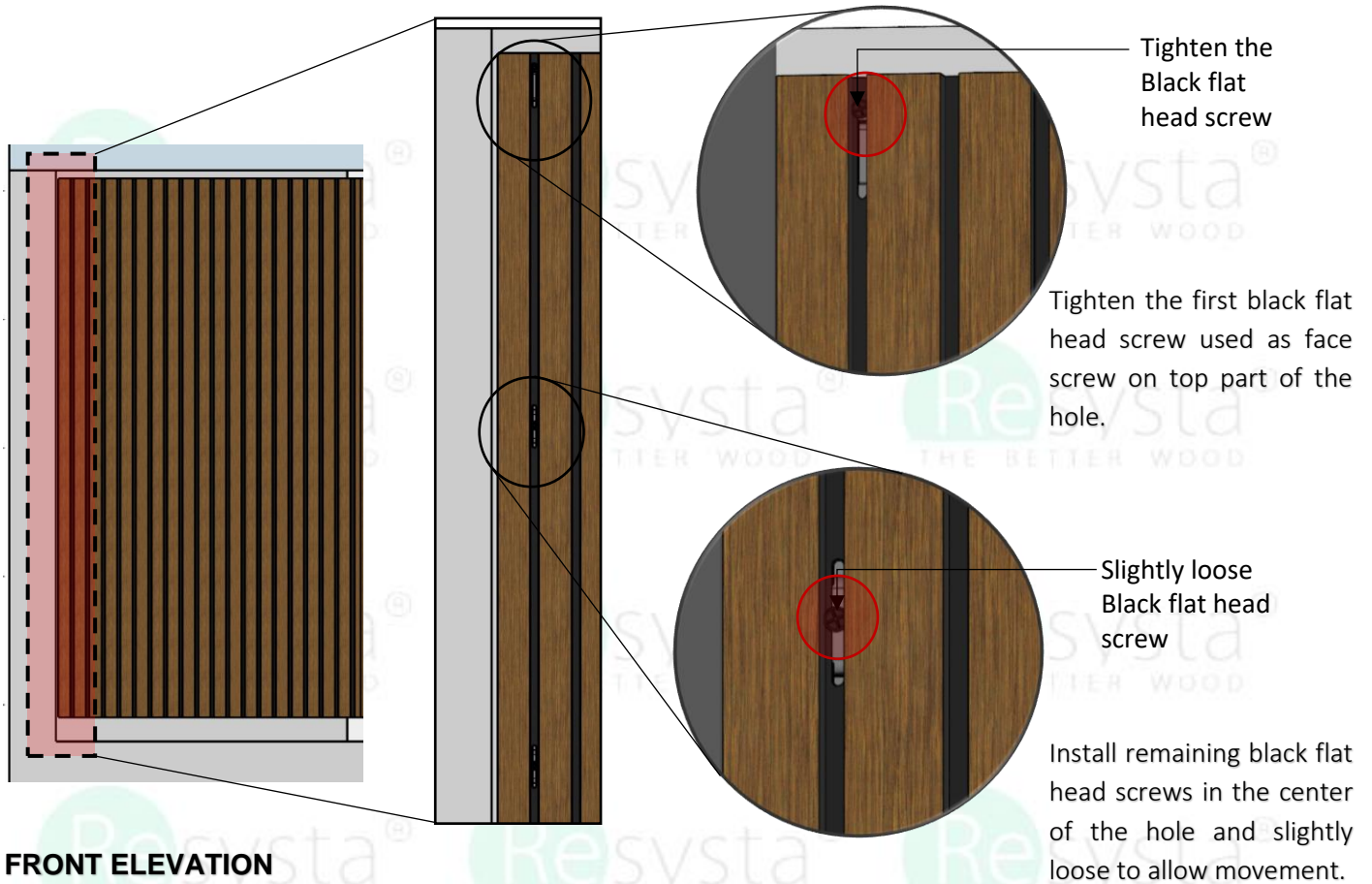

OPTION 02 Cutting the female part RESLP340612
(BOARD ENDING PERPENDICULAR INTO A WALL)

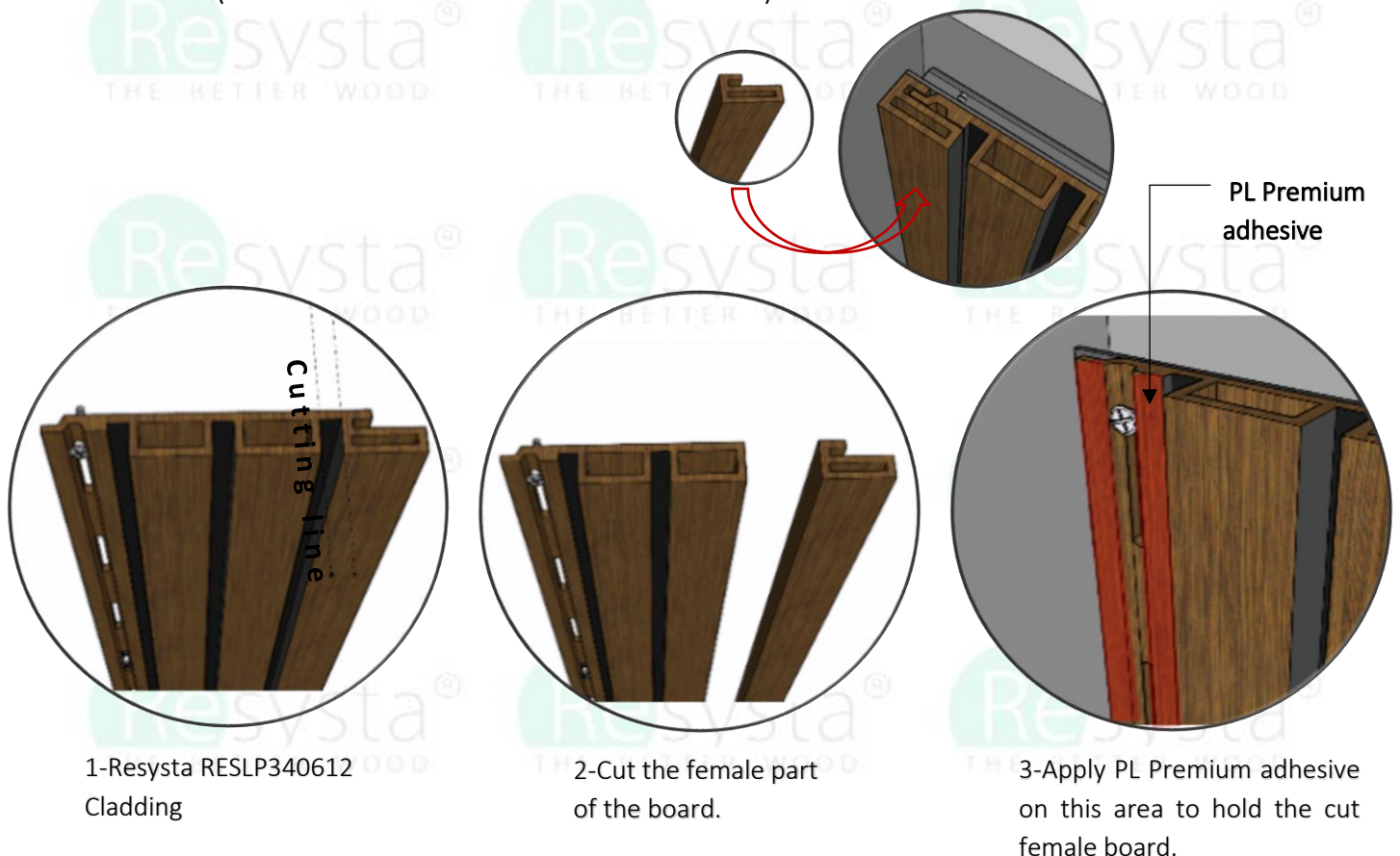

RESCPSS25 Screw

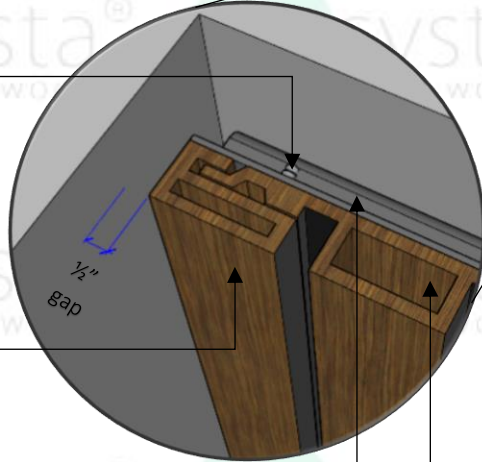

**Cut Female
RESLP340612**

**Reverse Hat
Channel**

RESLP340612

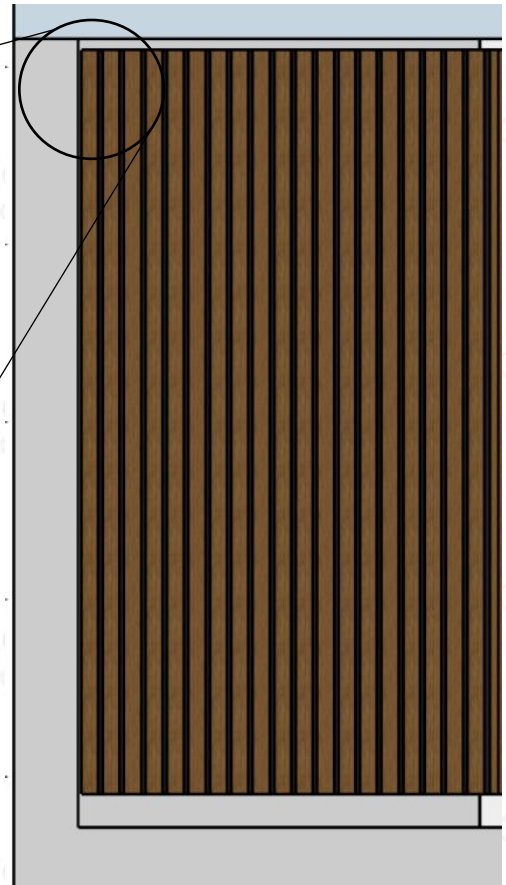

FRONT ELEVATION

2.9 To hide the exposed hat channel, glue together the cut RESLP340612 and RESIN25812 to the previous board tongue using PL Premium adhesive.

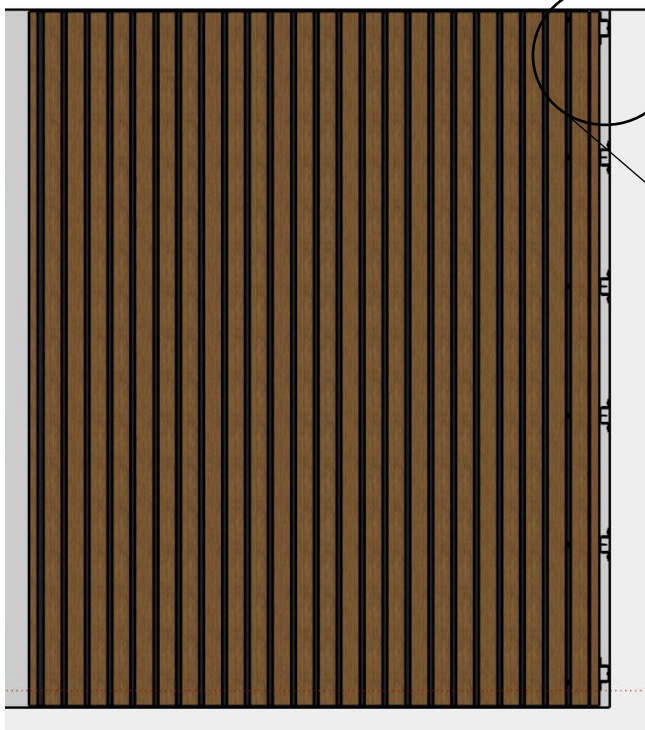

FRONT ELEVATION

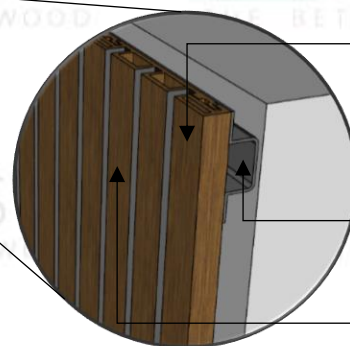

**Cut
RESLP340612**

**Exposed Hat
Channel**

RESLP340612

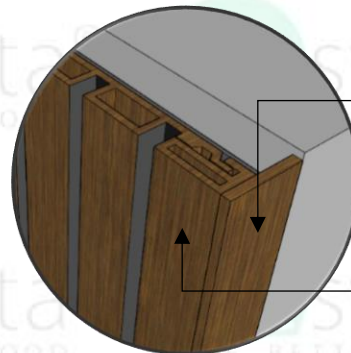

**RESIN25812
End Cap**

**Cut
RESLP340612**

END WALL DETAIL

Resysta RESLP340612 Termination Corner Details

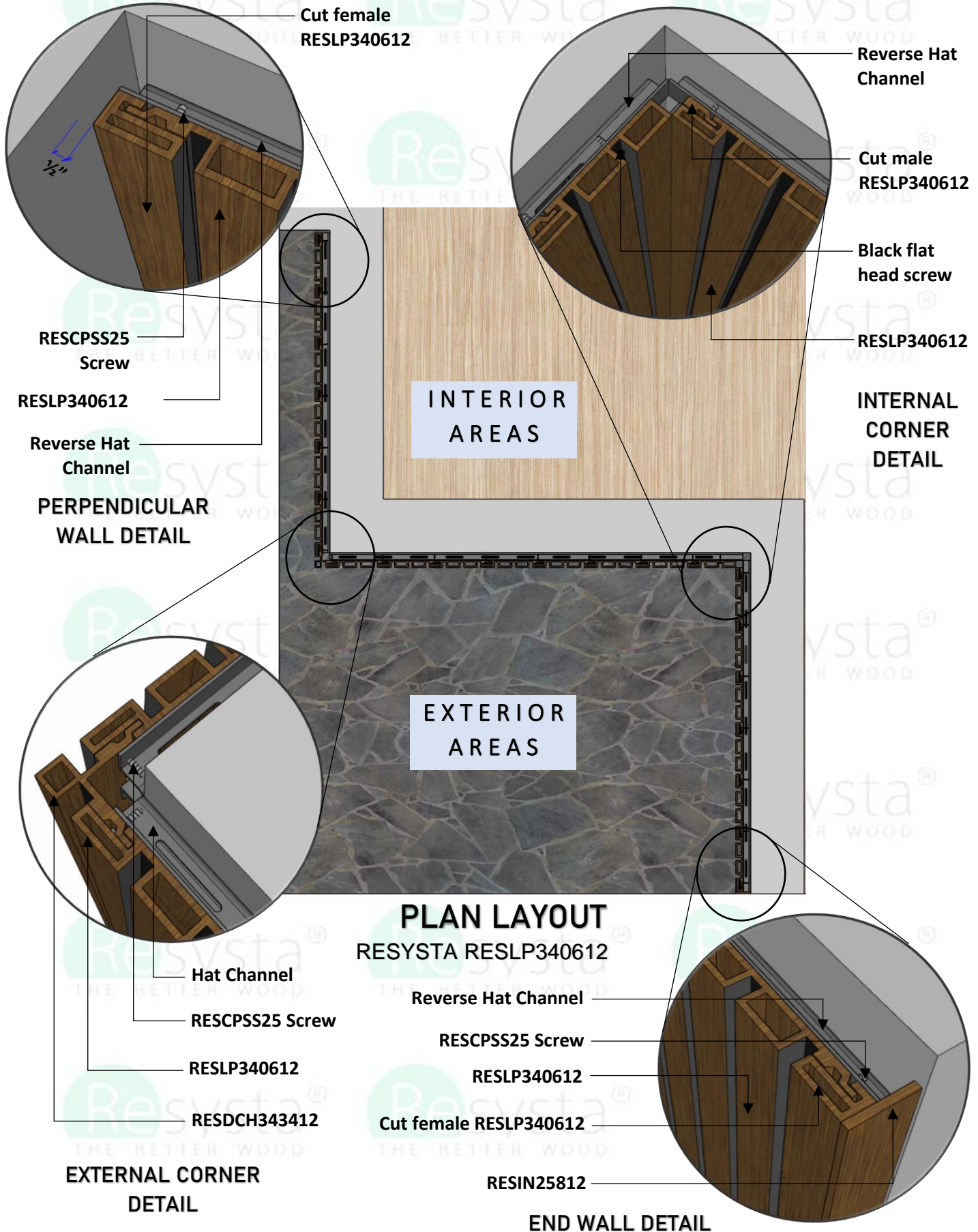

3. General Advice

3.1 Walls higher than 12' long

In case the project requires more than 12' long of Resysta Lusso Cladding it is advised to have a single butt joint termination for every set of two (2) RESLP340612. The single butt joint will be the location of the hard pinning of the boards, it will allow the boards to have an expansion joint. The boards can freely expand either moving upward or moving downward depending on the temperature or climate of the project.

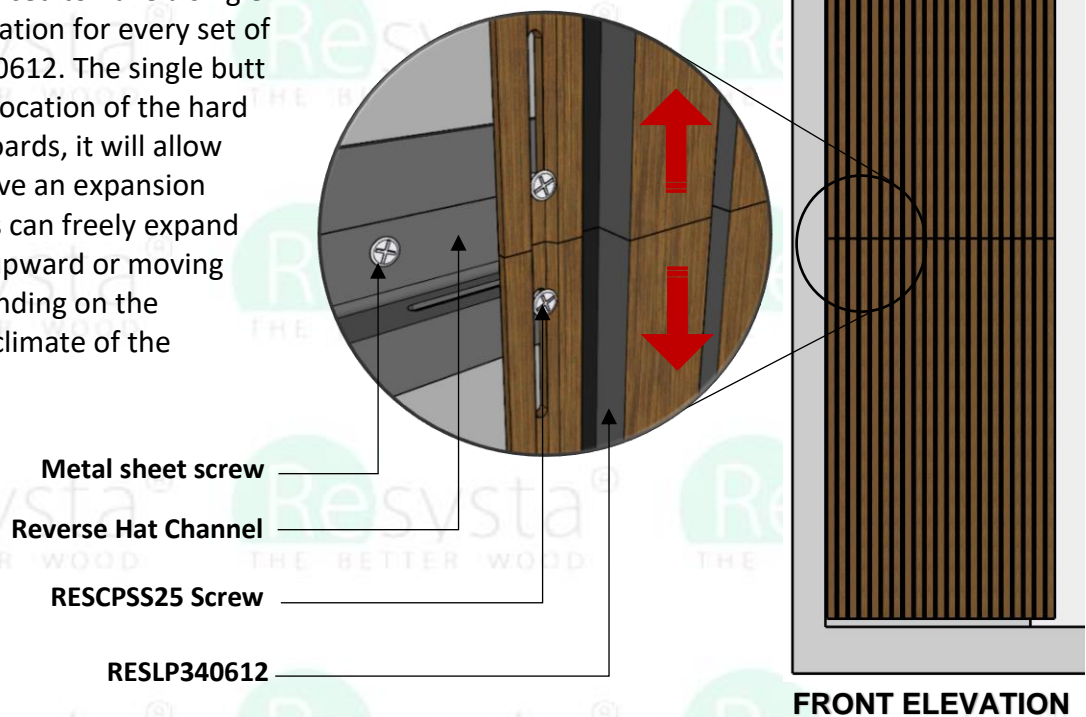

3.2 Expansion Joint

Expansion joint caters for temperature- dependent linear expansion of 1/16" gap per board every 10 degrees in temperature change between the ends of the planks. e.g. 9 1/2' plank= approx. 1/8" distance. If the planks are installed closed to a wall the distance here should be 1/2". (Refer to expansion chart).

Table 1.1

Surface Temperature	Gap (9 1/2' board)	Gap (12' board)	Ending
30°C- 40°C	1/16"	1/8"	1/2"
15°C- 30°C	1/8"	3/16"	1/2"
40°C- 60°C	1/16"	1/16"	1/2"
60°C- 70°C	none	none	3/16"

3.2.1 The Dimensional change of Resysta is solely dependent on the thermal expansion. Air, humidity and water have no influence on dimensional change. Thermal expansion must be considered at installation.

- 3.2.2 Cutting to length should be carried out at consistent material temperature. Therefore, the materials should be stored in the shade or in areas where it is not exposed to direct sunlight. The material can warm up considerably in the sun, leading to an increased change in length. In the case of more distinct fluctuations in material temperature, cutting to length may have to be adapted accordingly.
- 3.2.3 Resysta has a high vapor diffusion resistance. Please consider at installation.
- 3.2.4 Resysta has a class A fire rating (ASTM-E84).
- 3.2.5 Cut-off pieces and/or abrasive dust have to be disposed separately. Please comply with regulations of your competent waste management. You may under no circumstances burn Resysta yourself.

3.3 General Notes

- 3.3.1 Resysta building products is not responsible for information shown on all details beyond specification scope of work BID/quoted and as indicated contract documents.
- 3.3.2 Details of adjustment work are shown for completeness only. The project Architect / Project Engineer / Erecting Contractor supplying and/or installing the structural support is responsible for its design/installation to accommodate all loads imposed upon the products.
- 3.3.3 Our Engineer is limited to the load carrying components of the siding system and its fasteners shown on the subsequent drawings. The components are supplied by other parties.
- 3.3.4 These drawings are the copyright property of Resysta Building Products, Inc.
- 3.3.5 Please read our installation and design recommendation documents for further information that may be important for your specific project or installation.
- 3.3.6 Ensure a steady material temperature when cutting the boards to size. The cutting has to be done under constant conditions. e.g. inside or in shade.
- 3.3.7 Always consider the linear expansion of Resysta, which is dependent on the temperature but not air humidity. See Table 1.1 for more information.
- 3.3.8 Minimum runner/batten spacing for the 8" siding system.
- 3.3.9 Slots should be used to attach siding to runner/battens.
- 3.3.10 Overhang siding boards to a maximum of 1".
- 3.3.11 Only use construction fastening material and hardware suitable for outdoor use (e.g. Stainless Steel Screws).

3.4 Disclaimer

Resysta Lusso Cladding has been specially developed for their named application and are not a structural material. The items have no general technical approval and are therefore not suitable for supportive construction purposes. Local building codes as well as installations and technical information should be considered. Resysta products should be stored on a flat and level surfaces. If planks are stored on stickers/slats ensure that there is a distance of no more 12" between them. The Resysta cladding must be installed by an authorized professional installer.

For more details please visit our web site <https://www.resystausa.com>