

INSTALLATION GUIDE

RESYSTA SIDING ON THE SOFFIT & CEILINGS

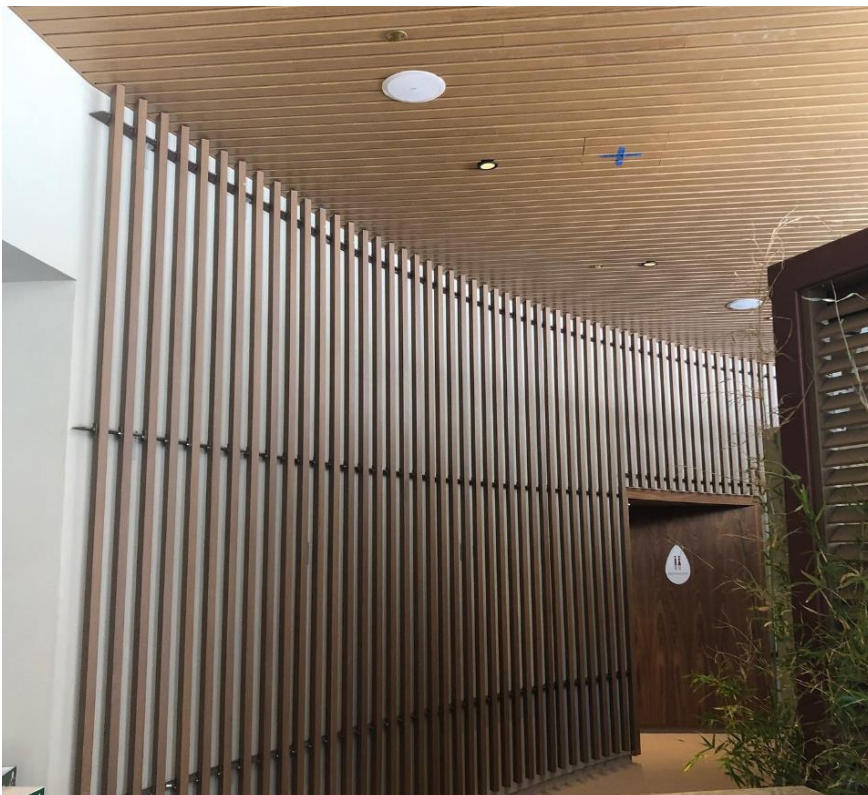

1. Introduction

Sec.1 Material Components

Sec.2 Basics

Sec.3 Scope of Profiles

2. Installation – Procedure

Sec.1 Review the Reflected

Ceiling Plan (RCP)

Sec.2 Battens Substructure

Sec.3 Trim and Accessory Option

Sec.4 Installation of Siding Board

Direct into the Ceiling Joist

Sec.5 Direct on Ceiling Joist Multi-

Board Soffit and Ceiling

Applications

Sec.6 Installation of Siding Board

into Resysta Runner Under

Substructure Plywood

Sec.7 Substructure Plywood Joist

Multi-Board Soffit and Ceiling

Applications

Sec.8 Board Termination Trim

Sec.9 Pinning Board

Sec.10 Prime and Stain System

3. Safety Warning

1. Introduction

Resysta is an extremely durable, timber look-alike, building material. It is resistant to damage from the sun, rain, frost and even salt water. Unlike wood, it requires minimal maintenance and is highly resistant to pests, mold and cracks. Unlike other composite materials, it closely resembles the look and feel of natural wood, with a smooth surface finish. Resysta meets most of the future environmentally sustainable material requirements concerning recycled and fully recyclable materials. Resysta is used for its architectural aesthetic, and not for structural support.

SECTION 1 - Material Components

A combination of these three basic raw materials makes up the simple components that create Resysta. This innovative material offers designers and architects new creative horizons to utilize its compelling and unique appearance.



Approx. 60% RICE HUSK + Approx. 22% COMMON SALT + Approx. 18% MINERAL OIL = RESYSTA

SECTION 2 - Basics

OVERVIEW OF PARTS

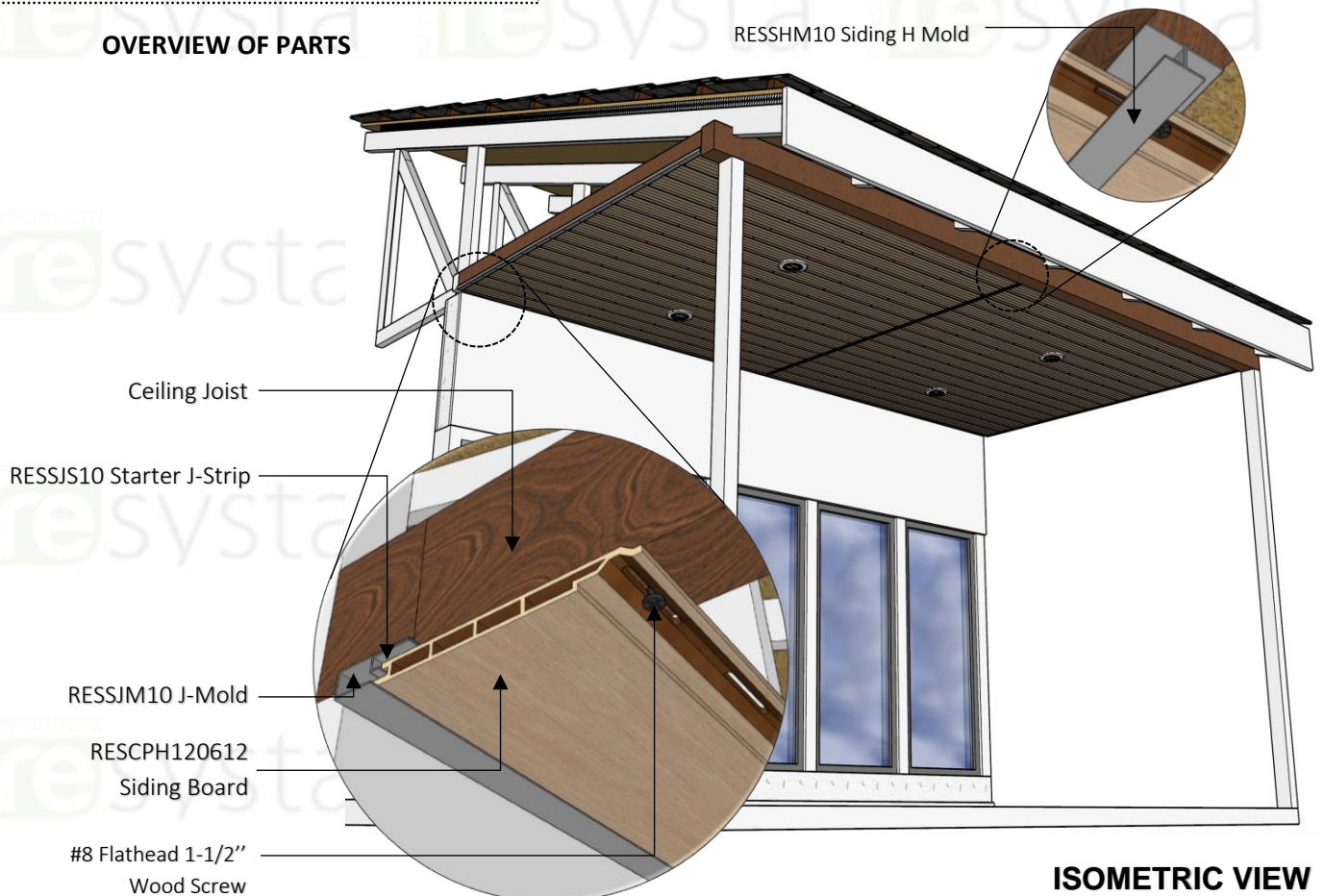

ISOMETRIC VIEW

BASIC PARTS OF SIDING BOARD (SOFFIT AND CEILING)

SECTION 3 - Scope of Delivery











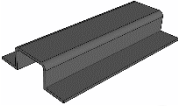

NO.	PRODUCT NAME AND SPECIFICATION	ISOMETRIC VIEW	FRONT VIEW
1	RESCPH120412 ½" x 4" x 12' Hollow Siding Profile		
2	RESCPH120612 ½" X 6" X 12' Hollow Siding Profile		
3	RESSHTC10 ¾" X 1 ½" Siding Hat Channel Mill Finish		
4	RESSJM10 5/8" x 1" J Mold		
5	RESSHM10 5/8" X 1" H Mold		
6	RESSJS10 Starter J-Strip		
7	RESCPSS25 1" TEC Shoulder Stainless Steel Screw		

Table 1.1 "Scope of Delivery"

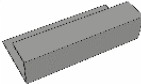
NOTE: Table above shows products commonly used for siding on the soffit and ceiling. To view a complete list of products, please refer to our Resysta brochure or visit our web site www.resystausa.com

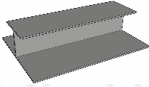
IMPORTANT:

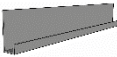
Five Major Bullet Points You Must Follow for a Successful Resysta Siding on the Soffit and Ceiling Installation

- **Screw Placement**
- **Room for Expansion and Contraction**
- **Hard Fastening of each Plank**
- **Top to Bottom Ventilation**
- **Span over 6" between supports, 3 hat channels are required**

NOTE:

Proper planning of the siding on the soffit and ceiling layout is essential for ease of installation of boards and components. Thoroughly read the following siding on the soffit and ceiling assembly instructions and obtain all necessary building permits prior to starting your installation. Decide finishing and trimming options prior to starting the project to ensure siding on the soffit and ceiling finishing detail is uniform for all sides of the building. Installation is the sole responsibility of the installer. Resysta Company assumes no responsibility whatsoever with respect to the installation. The information contained herein is provided for guidance purposes only and should not be relied upon as any absolute representation by Resysta.

Safety Tips:

1. Always check for power, gas, and water lines before installing.
2. Always wear safety glasses when operating power equipment.

Assembly Tips:

1. Battens should be flat and level to each other. Siding will follow the contour of the soffit and ceiling.
2. Proper wall preparation according to local building codes and wall covering manufacture’s recommendations should be adhered to. This includes but is not limited to flashing all openings.
3. All holes should be predrilled and installation holes should be slotted.
4. Only use construction fastening material and hardware suitable for outdoor use (e.g. stainless steel screws). Recommended is the use of RESCPSS25 shoulder screw.
5. Always consider the linear expansion of Resysta, which is dependent on the temperature but not the air humidity. See Table 1.2 “Resysta Expansion” for more information.
6. Cut-off pieces and/or abrasive dust must be disposed of separately. Please comply with regulations of your competent waste management. You may under no circumstances burn Resysta material.
7. Cutting to length should be carried out at consistent material temperature. Therefore, the material should be stored in the shade or in areas where it is not exposed to direct sunlight. The material can warm up considerably in the sun, leading to an increased change in length. In the case of more distinct fluctuations in material temperature, cutting to length may have to be adapted accordingly.
8. Please store Resysta products flat on level surface.

Code Compliant Batten Spacing

Part Number	Part Description	Batten Span (in)	Minimum Steel Gage Size
RESCPH120612	Siding Board Flat 1/2" x 6" (0.530" x 6")	16	18
RESCPH120412	Siding Board Flat 1/2" x 4" (0.530" x 4")	16	18

Table 1.2 "Batten Spacing Requirements"

Recommendation for Batten Spacing

If the siding on the soffit and ceiling is being installed in a hot southern location and will be exposed to direct sunlight for the majority of each day and/or the siding will be stained a dark color, the batten spacing is suggested be reduced to 8" or 12" center-to-center for all siding on the soffit and ceiling profiles.

Expansion / Contraction of Siding on the Soffit and Ceiling

Resysta Expansion – Contraction Guide	
Profile Length	12 ft
Expansion / Contraction amount (approx.. 0.3% over 90 oF variation in temperature)	7/16" (0.432")

Table 1.3 Expansion – Contraction: Average expected expansion – contraction (this can vary based on geographical region).

Resysta Siding Board Gap Guide					
Temperature at Installation	Trim Gap of Siding Boards				H-Channel Gap
	Below 30 oF	60 oF	90 oF	120 oF	
Amount for Siding Profile Length of 12 ft.	7/16"	5/16"	3/16"	0"	1/4"

Table 1.4 "Resysta Expansion" – Ensure a steady material temperature when cutting the boards to size, i.e. the cutting has to be done under constant conditions, e.g. inside or in shade.

Always consider linear expansion of Resysta profiles during the installation of the siding on the soffit and ceiling products. If temperatures fluctuate during the installation, the gaps placed between the ends of the boards and a corner, window, or door must change with the temperature. Use the guide above to gap boards during installation

Expansion – Contraction Tips:

1) Control Piece

at the start of the day cut a length of board that is desired to be installed and keep this board in the same area as the cutting and storage of the remaining boards. This board will be a "Control Piece" to reference when cutting other boards to be installed. Throughout the day the "Control Piece" can be referenced and the saw cuts adjusted accordingly as the boards expand and/or contract. Heat from the sun will cause Resysta boards to expand so if the material is stored in the shade keep the "Control Piece" in the shade as well.

Example:

If 12ft boards are being installed put aside one 12ft board at the start of the day. Reference these boards throughout the day and adjust the cutting of the other boards to match

2) Control Gap

at the start of the installation place the siding gap according to Table 1.4 and mark the first gap made. This gap will be a "Control Gap" to reference when gapping the remaining boards to be installed. Throughout the installation reference back to this "Control Gap" to match the other gaps being installed. This will ensure that all the gaps installed are the same.

2. Installation - Procedure

SECTION 1 – Review the Reflected Ceiling Plan (RCP)

Before starting the installation, it is advised to well study the Reflected Ceiling Plan (RCP). The Reflected Ceiling Plan (RCP) is an architectural drawing, showing the placement of the lighting, sprinklers, smoke detectors, and other mechanical or electrical components. By studying the RCP, you can assess the affected areas where the siding profile on the soffit and ceiling is being installed.

RCP KEY NOTES AND LIGHTING SCHEDULE		
TYPE	SYMBOL	DESCRIPTION
1	①	SKYLIGHT ABOVE. SEE 1/A2.4 FOR SKYLIGHT SIZING.
2	②	CONTINUOUS VENTING STRIP. REFER TO ROOF VENTILATION TABLE ON SHEET A2.4. CONTRACTOR TO VERIFY ROOF EAVE VENT SIZES ON SITE DURING CONSTRUCTION AND TO LOCATE CONTINUOUS VENT STRIPS WITHIN STRUCTURAL REQUIREMENTS FOR PENETRATION.
3	○ _A	4" RECESSED DOWNLIGHT - LED
4	⊗ _B	SURFACE MOUNTED FIXTURE - LED
5	⊙ _C	LARGE SUSPENDED DECORATIVE PENDANT - LED
6	⊕ _D	WALL SCONCE
7	▣	CAT VII (ETHERNET ONLY) CEILING-MOUNTED
8	⊗ _E	EXHAUST FAN

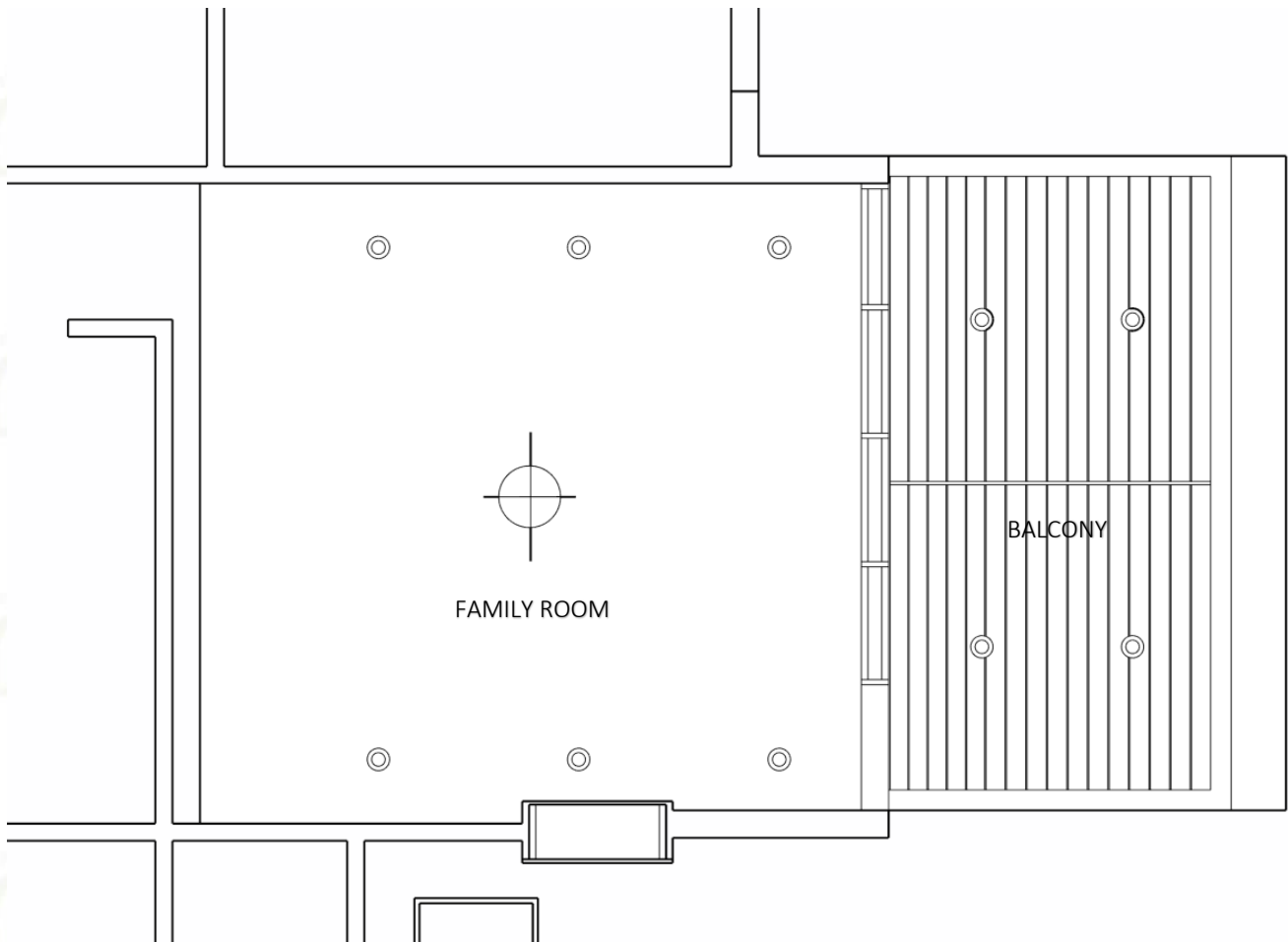

REFLECTED CEILING PLAN (RCP)

Siding on Soffit and Ceiling layout

SECTION 2 – Batten Substructure

General Notes on Batten Substructure

Resysta siding boards on the soffit and ceiling can be installed in horizontal or vertical applications and the batten substructure should be planned to accommodate how the siding boards will be installed. Note that there are two substructures that Resysta battens can be installed whether: Substructure 1. Direct on Ceiling joist or Substructure 2. Resysta Runners under Substructure Plywood.

Substructure 1

Direct on Ceiling Joist



ISOMETRIC VIEW
SUBSTRUCTURE 1

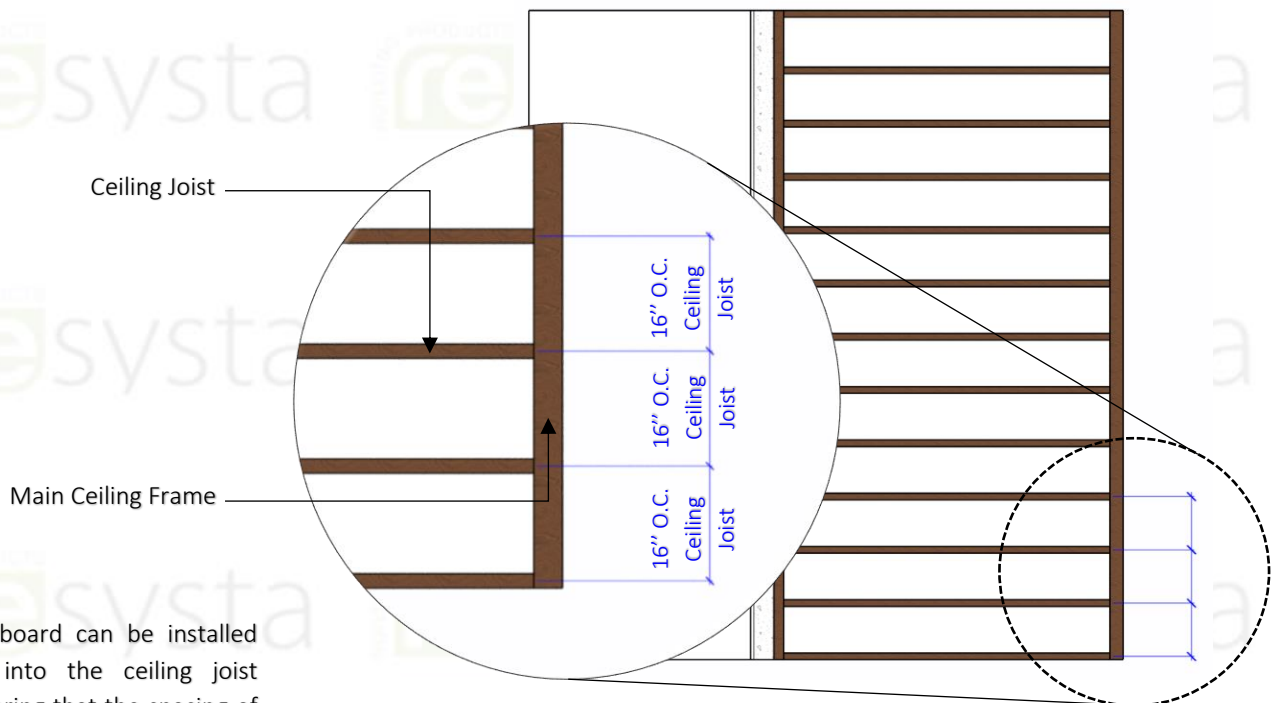

PLAN
SUBSTRUCTURE 1

Note:
Siding board can be installed direct into the ceiling joist considering that the spacing of the joist is 16" or less.

Substructure 2
Resysta Runners under
Substructure Plywood

Roof rafter
1/2" Plywood
substructure over joist
Post

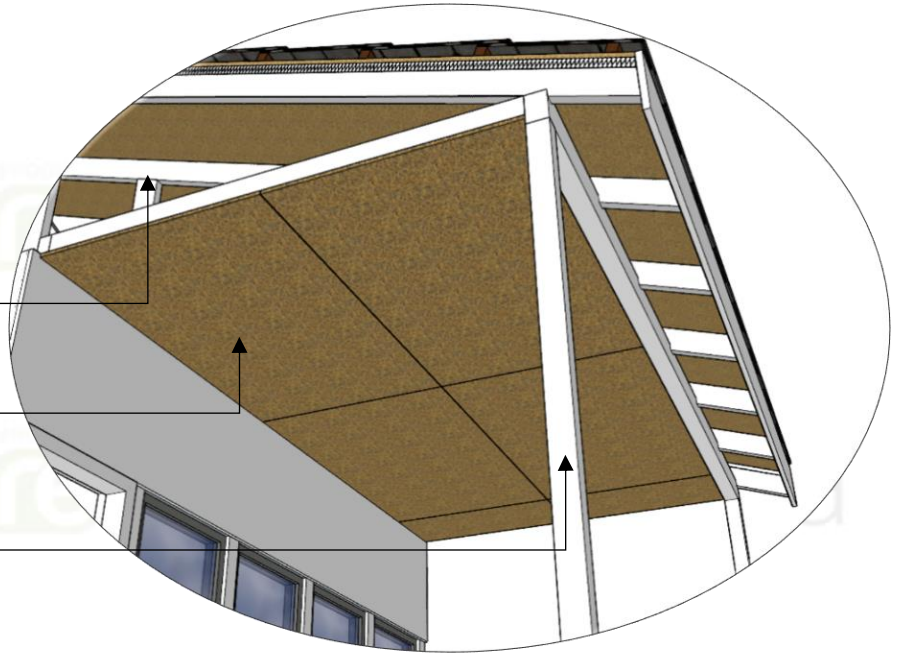

ISOMETRIC VIEW
SUBSTRUCTURE 2



ISOMETRIC VIEW
SUBSTRUCTURE 2

Note:
Install the aluminum hat channel runners under the 1/2" plywood sub ceiling support with 12" to 16" on center runner spacing before installing the siding board.

Reverse RESHTC10 Hat Channel
1/2" Plywood substructure
over joist
RESHTC10 Hat Channel

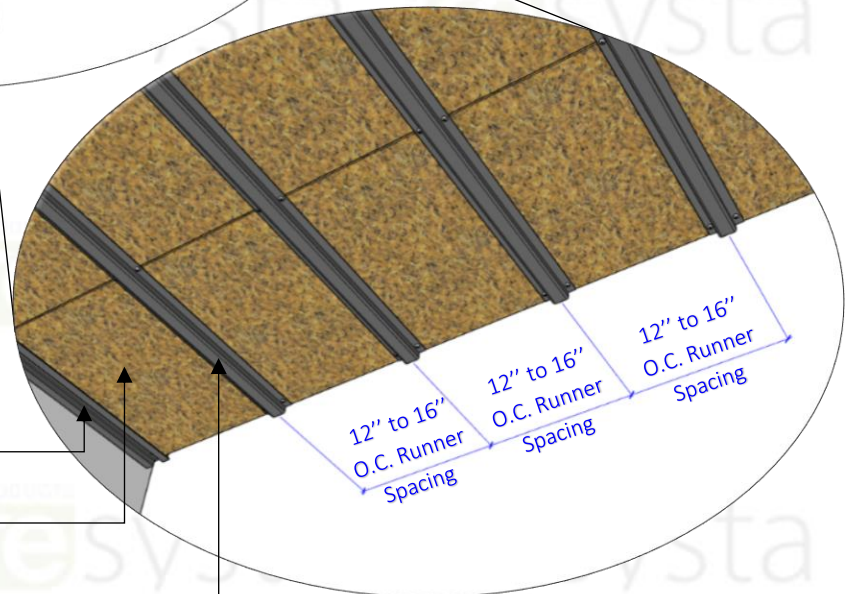

ISOMETRIC DETAIL
SUBSTRUCTURE 2

Resysta Aluminum Batten Substructure

Install the battens and secure to the frame substructure in compliance with local building codes. Ensure that the installed battens do not exceed the “Batten Spacing Requirements” of Table 1.2. On the soffit and ceiling where two siding boards will be used end-to-end, a minimum of two battens must be used to accommodate the fastening of the siding boards and any trim pieces desired to the batten substructure where the boards meet. Prior to installing the Resysta siding boards on the soffit and ceiling, ensure that the batten installation provides a minimum $\frac{3}{4}$ ” air gap behind the siding boards on the soffit and ceiling, and there is sufficient support for all boards and trim accessories. This is often achieved through the installation of battens with a minimum thickness of $\frac{3}{4}$ ”

Battens should be installed on top of a code compliant sheathing with fasteners and fastener spacing sufficient to accommodate all loads imposed upon it by the Resysta siding board on the soffit and ceiling, trim components, and any other accessories attached to the battens. Resysta siding boards must be attached to aluminum battens with Resysta shoulder stainless steel screws (RESCPSS25 Screw) taking care to not penetrate the weather barrier. If the weather barrier is going to be penetrated reference the weather barrier manufacture’s recommendations.

Notes on Resysta Shoulder Screw RESCPSS25

SECTION 3 – Trim and Accessory Options

Aluminum Siding Trim systems made for Resysta siding boards are recommended for covering the ends and gaps of siding boards. Suggested supply includes, but is not limited to: Outside Corner Trim, Inside Corner Trim, Starter Strip (to start siding boards), H-Channel Trim (to cover wall gaps), J-Channel Trim (used for siding board termination). Aluminum Siding Trims are standard aluminum alloy 6063 T5 and have a .050” nominal wall thickness. Aluminum Siding Trims come in 10’ lengths and shall have a standard Mill Finish for field priming and painting unless otherwise specified.

Aluminum Siding Trim – General Installation Guidelines

Aluminum Siding Trim must be cut with a 150 tooth carbide-tip blade for nonferrous metal. Blade Lubricant must be applied to the blade before each cut and the lubricant should be cleaned from the trim prior to installation.

Resysta Aluminum Siding Trim – Aluminum Batten Installation Guidelines

When using metal battens, either steel or aluminum, it is recommended to use the RESCPSS25 Screw which can be driven through the aluminum siding trim and into the metal batten. Trim should be fastened 16” on center for either horizontal or vertical installations. If the batten substructure spacing is reduced for the siding boards on the soffit and ceiling the trim should be fastened at the same interval as the board. Be aware of fastener placement for the trim so as to not hinder the installation of the Resysta siding boards on the soffit and ceiling.

SECTION 4 – Installation of Siding Board Direct into the Ceiling Joist

Substructure 1 Direct on Ceiling Joist

STEP 4.1

Pre apply all finishing trim accessories such as trim around corners, skylights, and other pre plan layout ceiling components and following the manufacture’s recommendations. Ensure that all trim is level and square.

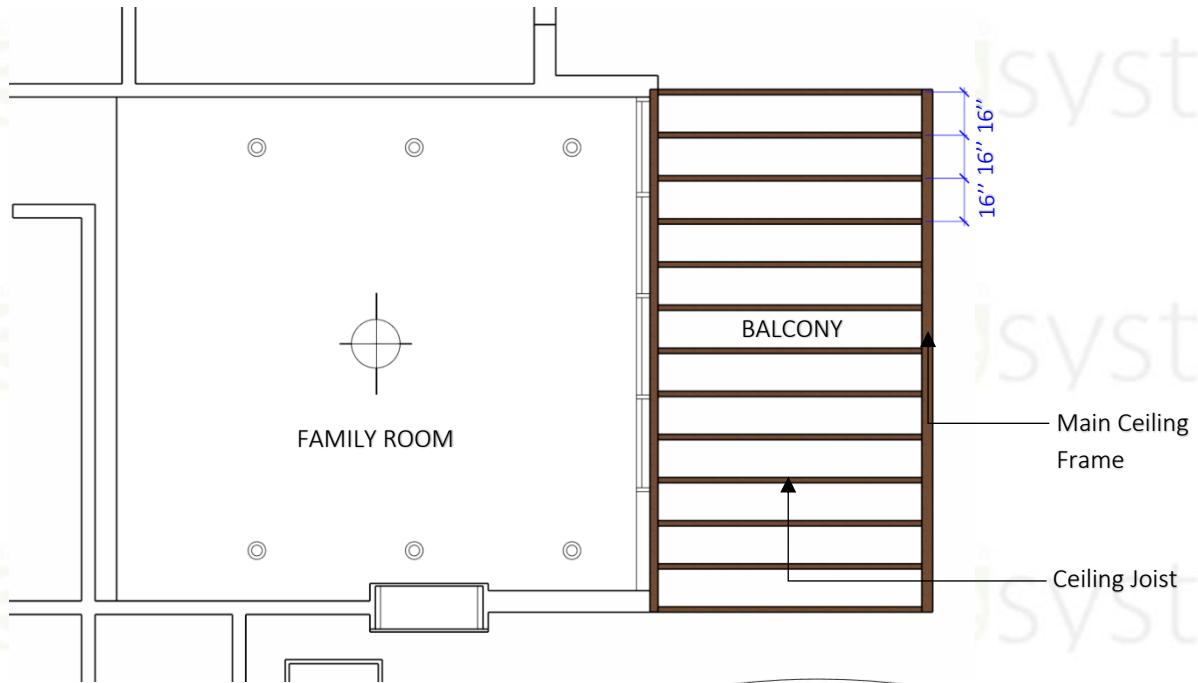

REFLECTED CEILING PLAN
CEILING JOIST LAYOUT

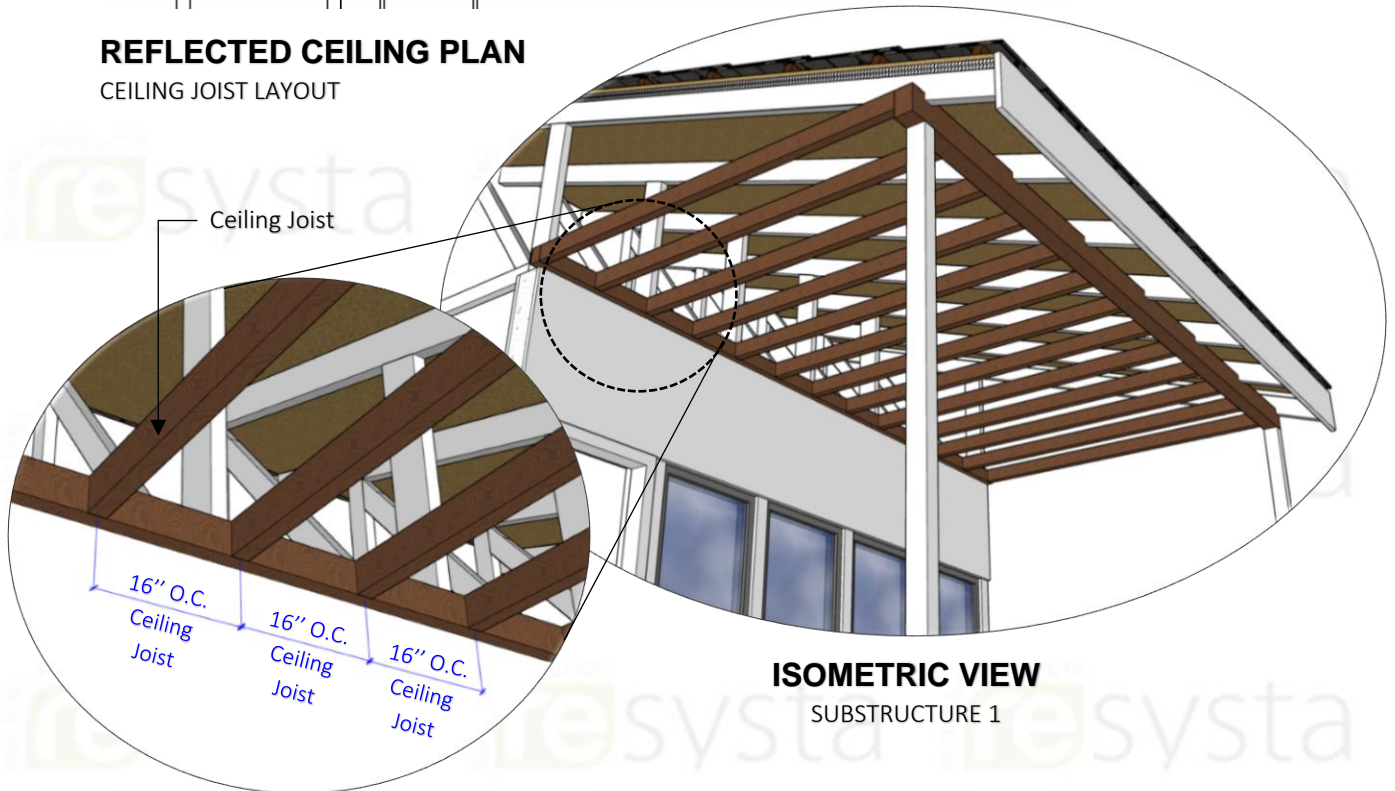

ISOMETRIC VIEW
SUBSTRUCTURE 1

ISOMETRIC DETAIL
SUBSTRUCTURE 1

STEP 4.2

Attach the starter strip under the J-mold and install direct to the ceiling joist substructure. Aluminum starter strip is required to install the Resysta siding board on the soffit. The Resysta siding boards on the soffit will have a space of 1/2" from the J-mold to the wall therefore the starter strip should be attached accordingly as per the Reflected Ceiling Plan (RCP).

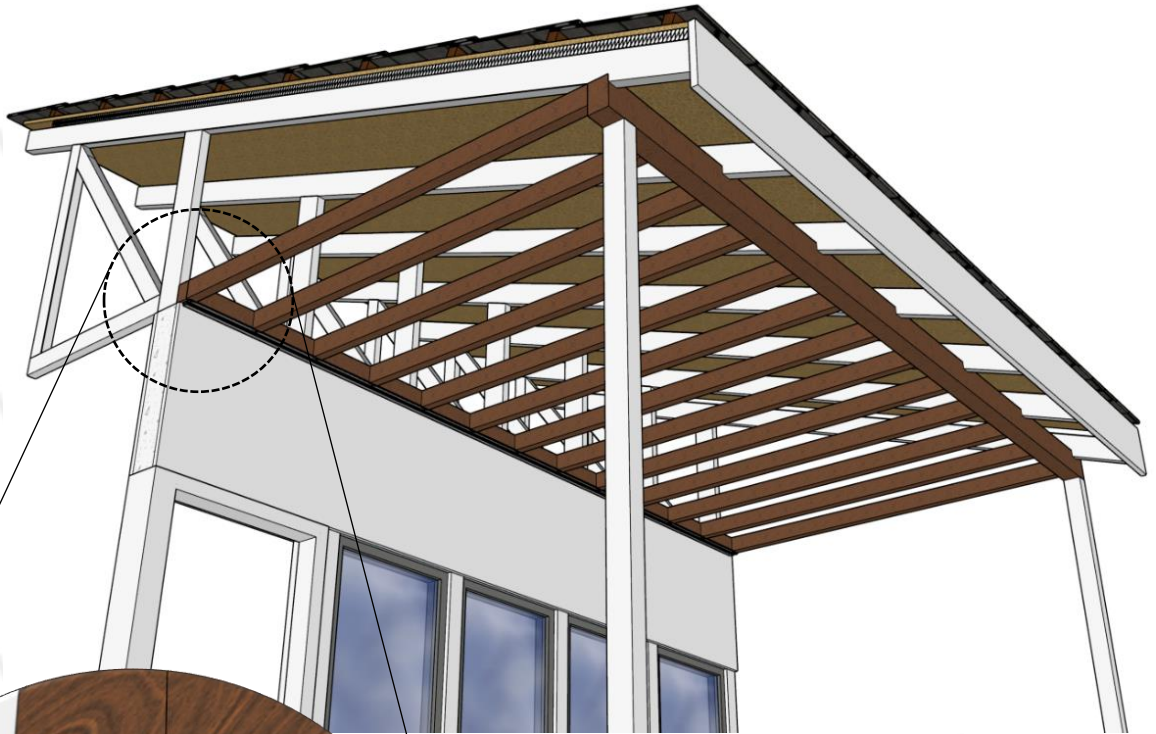

ISOMETRIC VIEW
STARTER STRIP AND J-MOLD

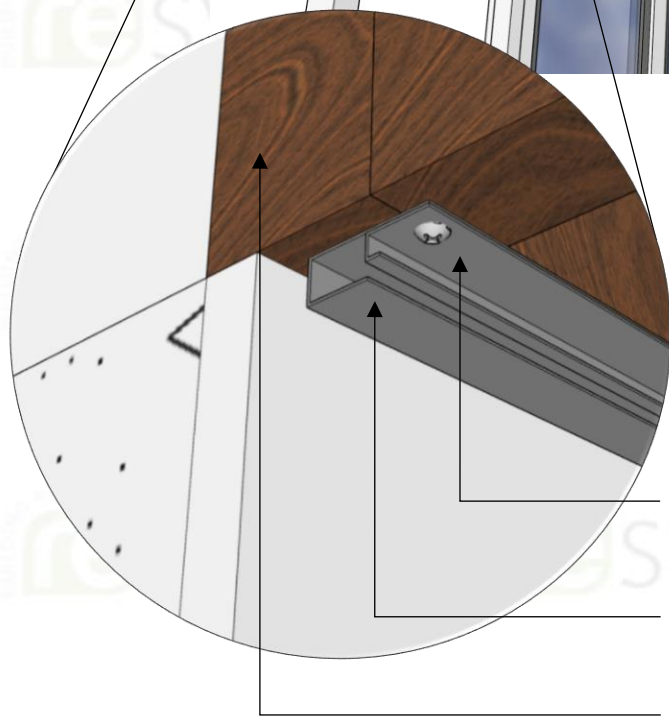

ISOMETRIC DETAIL
STARTER STRIP AND J-MOLD

RESSJS10
Starter J-Strip
RESSJM10 J-Mold
Ceiling Joist

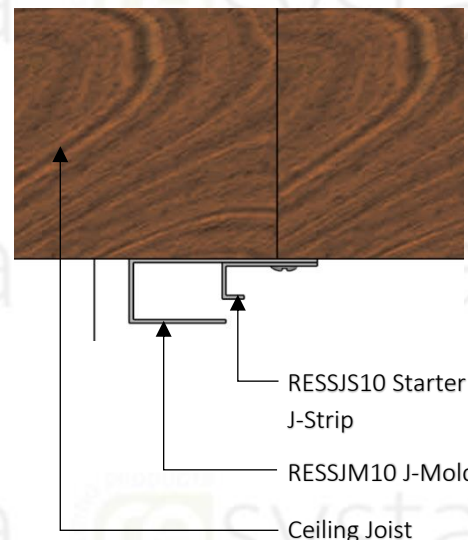

SECTION DETAIL
STARTER STRIP AND J-MOLD

RESSJS10 Starter
J-Strip
RESSJM10 J-Mold
Ceiling Joist

STEP 4.3

Hook the groove end of the first siding board into the Starter J Strip under the J-mold. Install #8 Flathead 1-1/2" wood screw into all slotted holes except the center hole. DO NOT over tighten the screws. The screws should be placed in the center of the slotted hole and loose enough to allow the board to move freely from side to side to allow for expansion and contraction. Install the final two #8 Flathead 1-1/2" wood screw in the slotted hole in the center of the board. This will allow for expansion and contraction evenly to each side of the assembly.



ISOMETRIC VIEW
SIDING BOARD ON SOFFIT

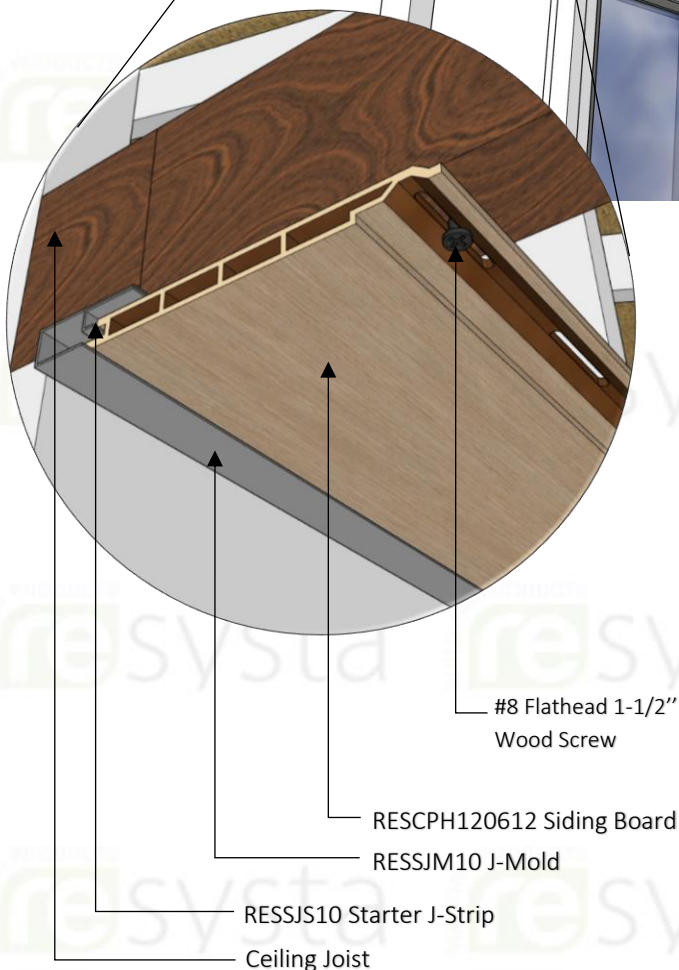

ISOMETRIC DETAIL
SIDING BOARD ON SOFFIT

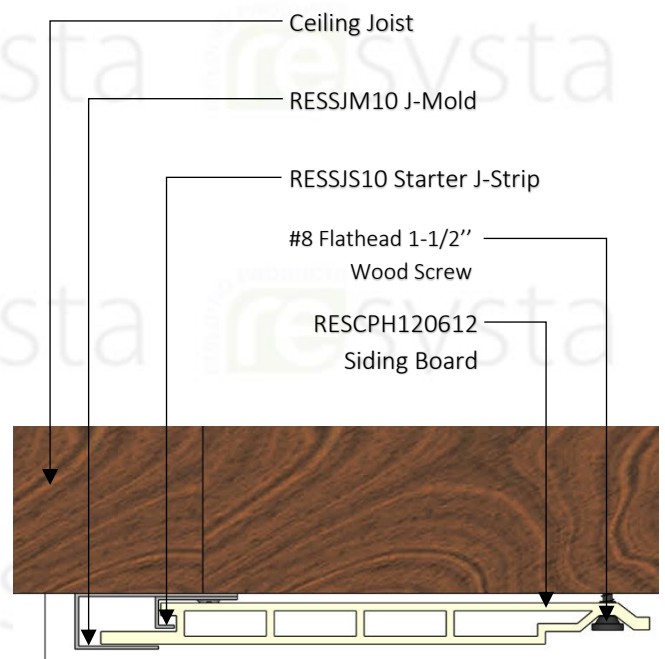

SECTION DETAIL
SIDING BOARD ON SOFFIT

STEP 4.4

Hook the groove end of the next board onto the tongue of the installed siding board. Continue to install the siding boards direct into the ceiling joist substructure together with the #8 Flathead 1-1/2" wood screw in the slotted hole of the board.

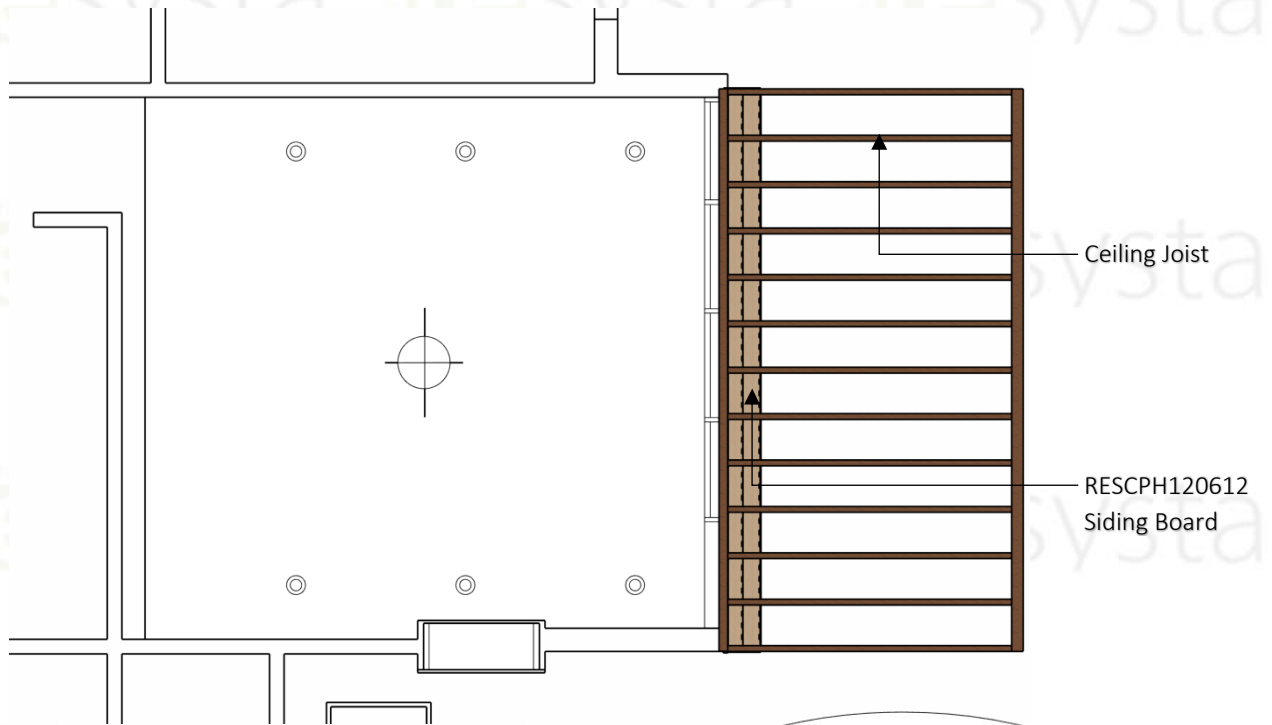

REFLECTED CEILING PLAN
SIDING BOARD ON SOFFIT

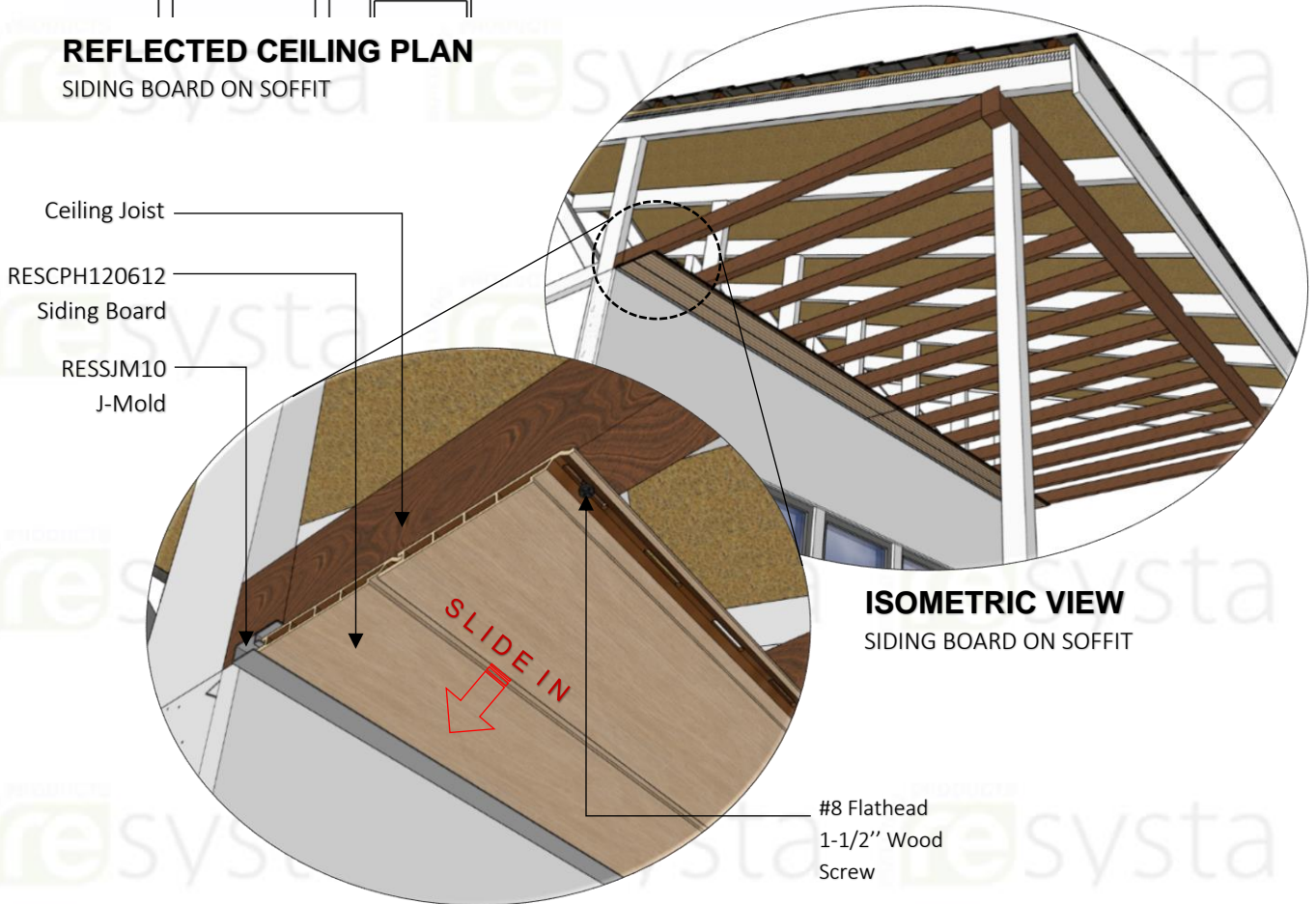

ISOMETRIC VIEW
SIDING BOARD ON SOFFIT

ISOMETRIC DETAIL
SIDING BOARD ON SOFFIT

STEP 4.5

Continue installing boards as outlined in Section 4.3. Rip last siding board into size to finished.

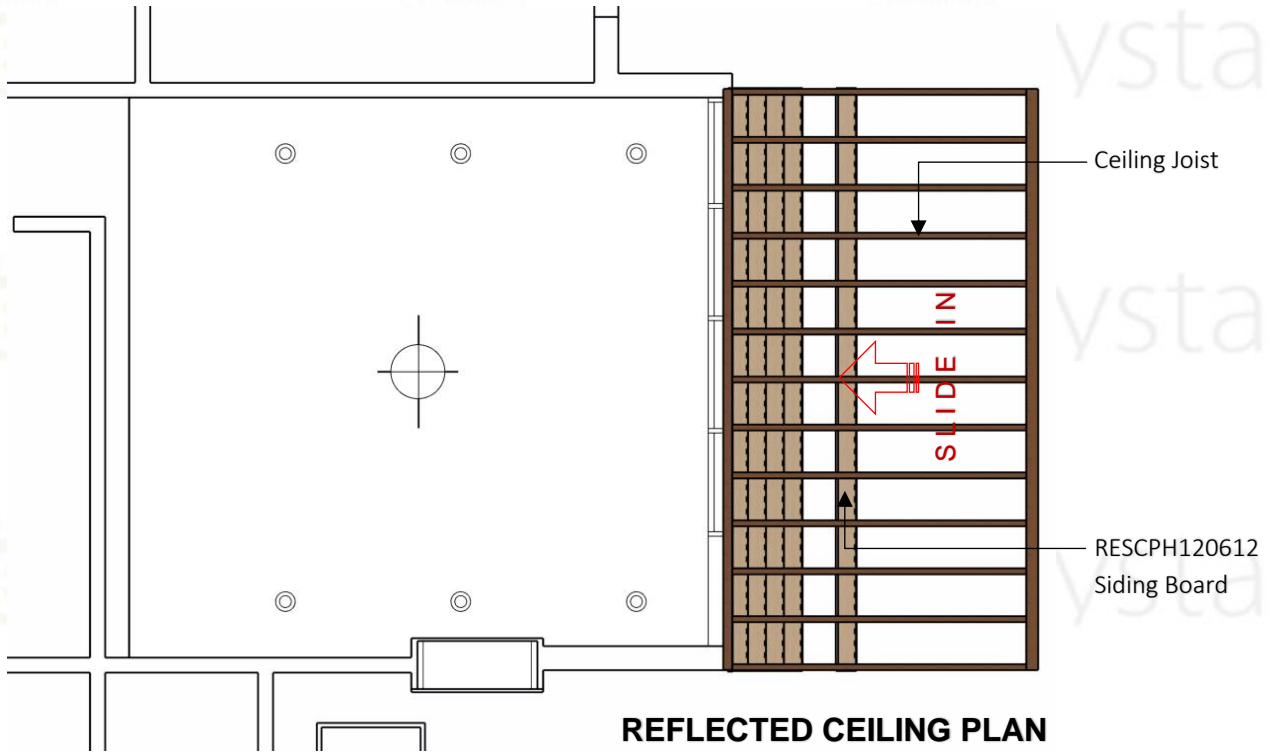

REFLECTED CEILING PLAN
SIDING BOARD ON SOFFIT

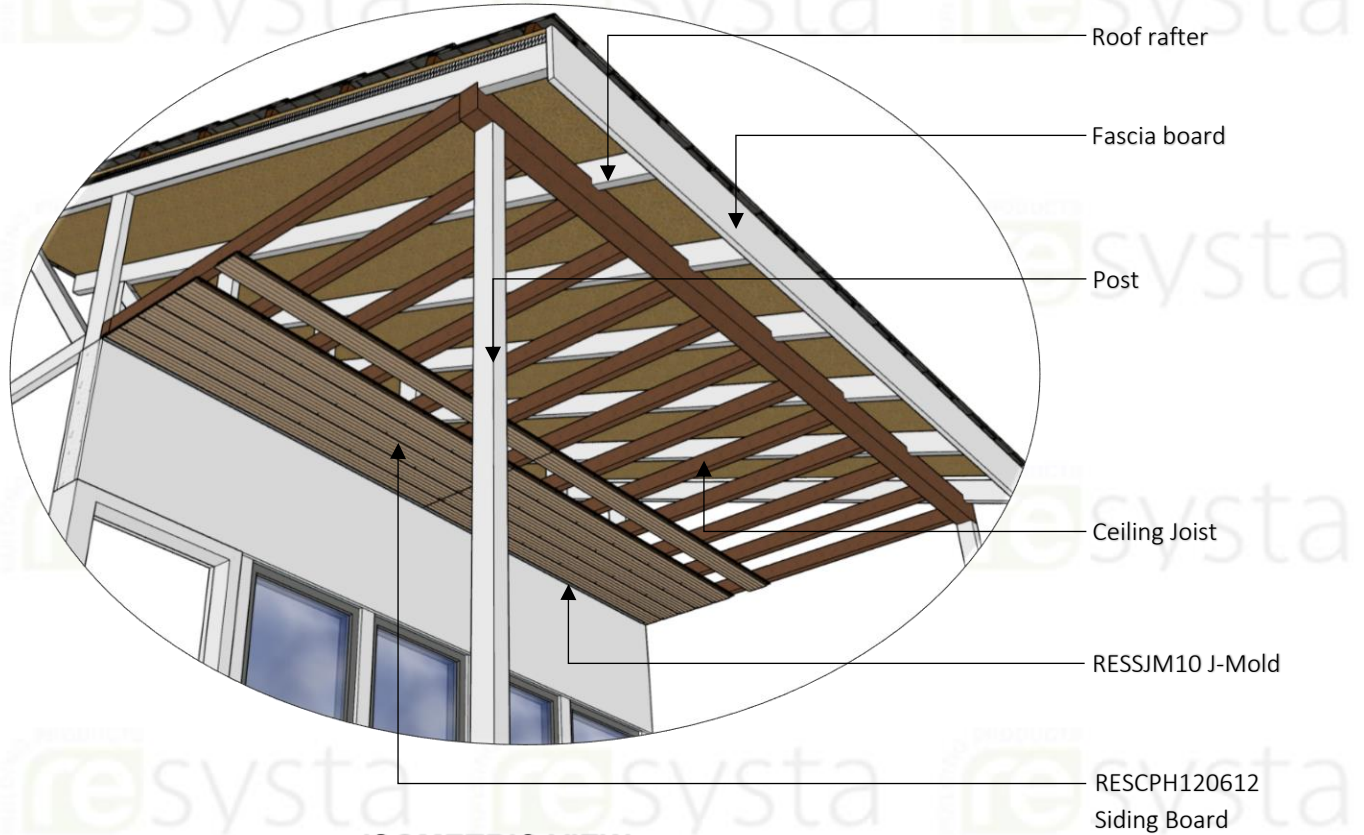

ISOMETRIC VIEW
SIDING BOARD ON SOFFIT

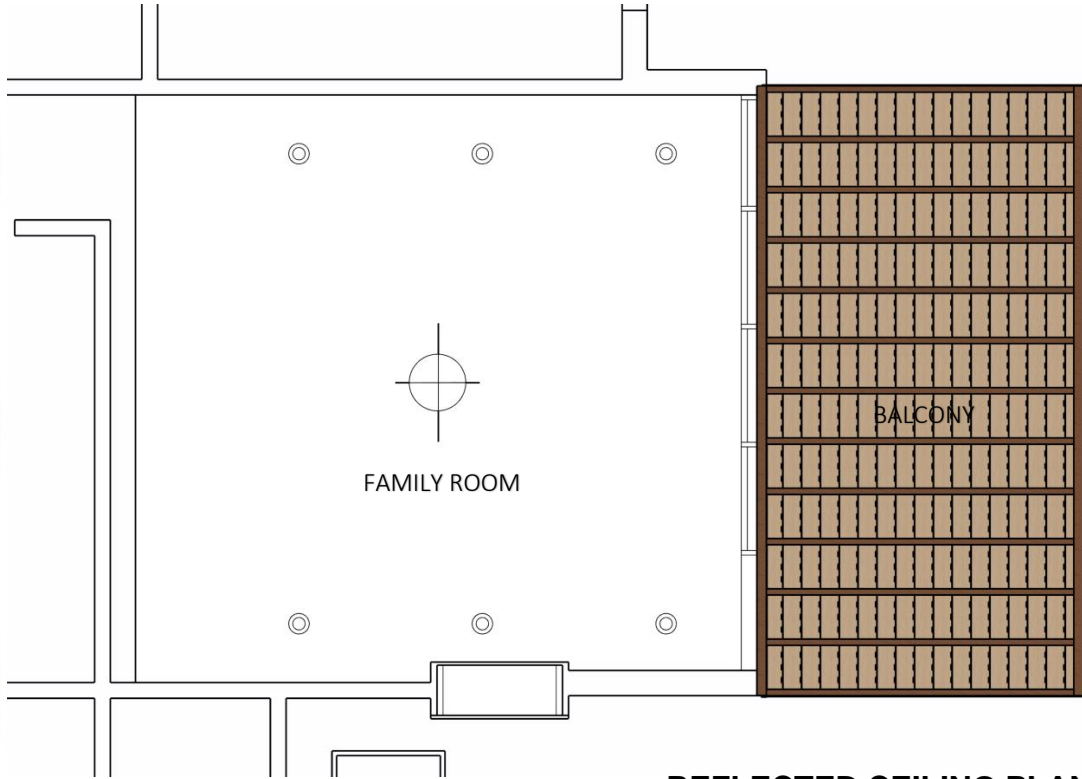

REFLECTED CEILING PLAN

SIDING BOARD ON SOFFIT



ISOMETRIC VIEW

SIDING BOARD ON SOFFIT

SECTION 5 – Direct on Ceiling Joist Multi-Board Soffit and Ceiling Applications

Substructure 1 Direct on Ceiling Joist

Multi-Board Wide Installation using Continuous H-Channel Trim on Soffit

Follow Steps 4.1, 4.2, and 4.3 from Section 4 to install finishing trim, starter strip, and hook in the 1st siding board on the soffit. An H-Channel should be installed at each board abutment joint to cover the ends of the Resysta siding board on the soffit. This is an option for installations using 3 or more boards abutted end-to-end on the soffit.



ISOMETRIC VIEW
SIDING H-MOLD

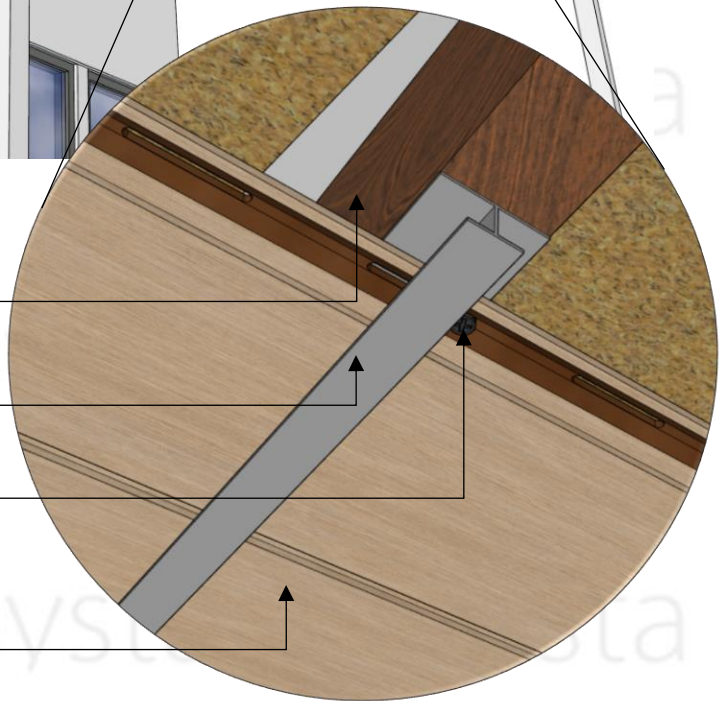

Ceiling Joist

RESSHM10 Siding H Mold

#8 Flathead 1-1/2"
Wood Screw

RESCPH120612
Siding Board

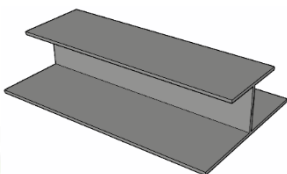

RESSHM10
Siding H Mold

ISOMETRIC VIEW
SIDING H-MOLD

SECTION 6 – Installation of Siding Board into Resysta Runners Under Substructure Plywood

Substructure 2 Resysta Runners Under Substructure Plywood

STEP 6.1

Install the aluminum hat channel runners under the substructure plywood, following the recommended runner spacing of 12" to 16" center to center of runners. Pre apply all finishing trim accessories such as trim after the installation of the runners around the corners, skylights, and other pre plan layout ceiling components and following the manufacture's recommendations. Ensure that all trim is level and square.

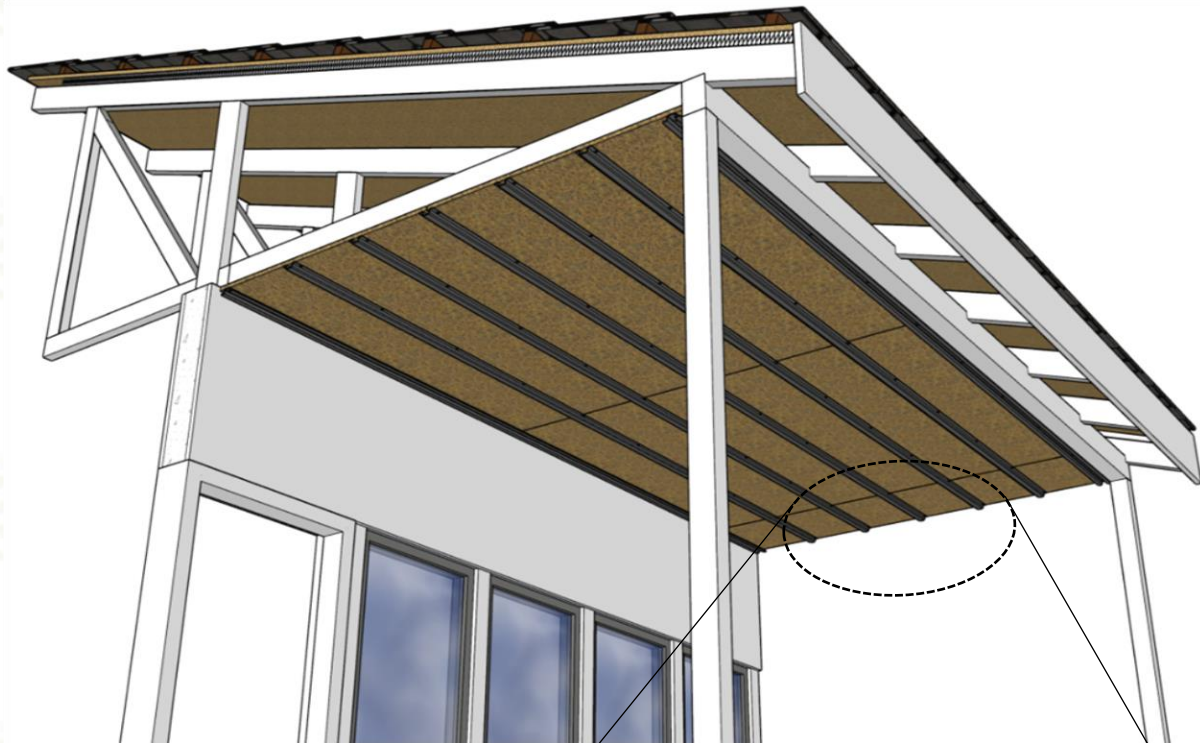

ISOMETRIC VIEW
SUBSTRUCTURE 2

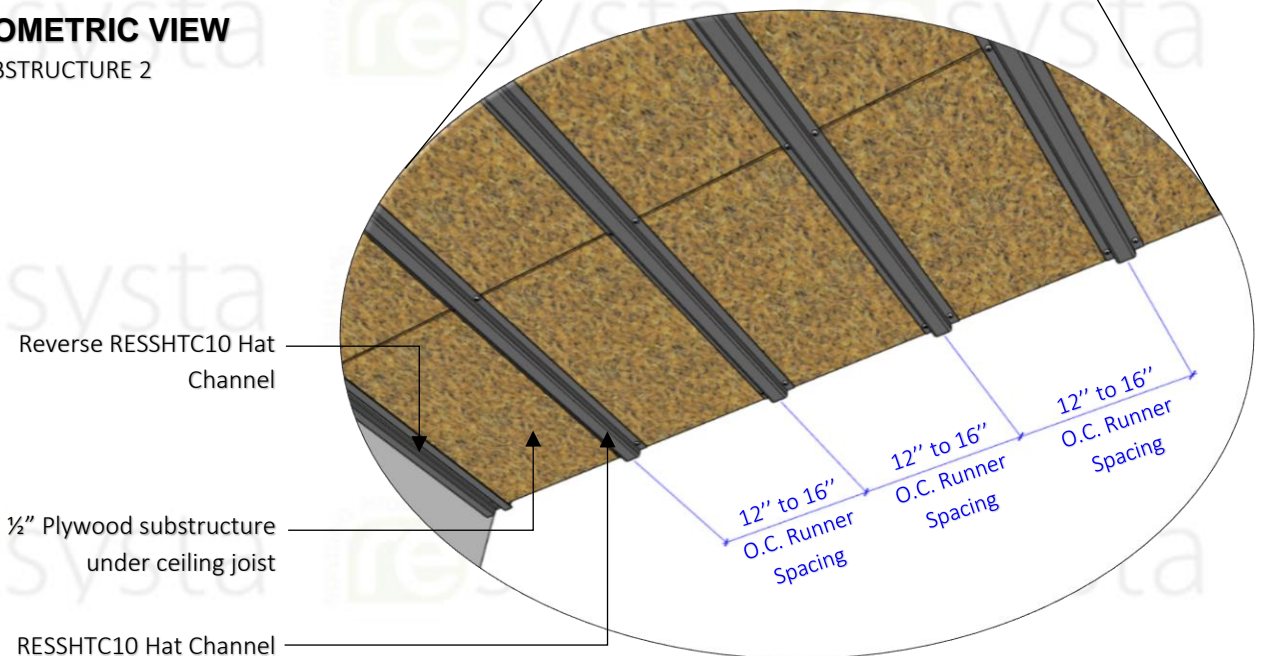

ISOMETRIC DETAIL
SUBSTRUCTURE 2

STEP 6.2

Attach the starter strip under the J-mold and install into the aluminum hat channel. Aluminum starter strip is required to install the Resysta siding board on the soffit. The Resysta siding boards on the soffit will have a space of 1/2" from the J-mold to the wall therefore the starter strip should be attached accordingly as per the Reflected Ceiling Plan (RCP).



ISOMETRIC VIEW
STARTER STRIP AND J-MOLD

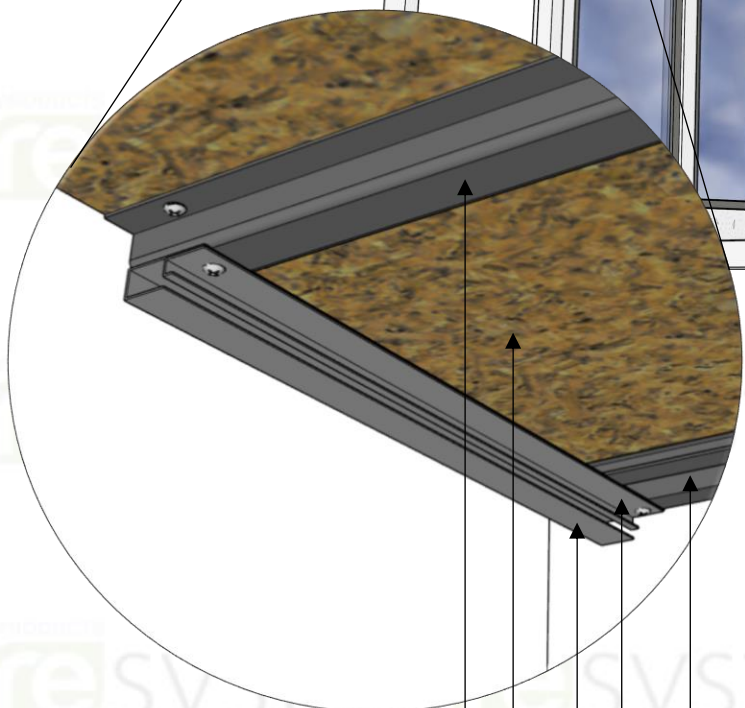

- RESSHTC10 Hat Channel
- 1/2" Plywood substructure under ceiling joist
- RESSJM10 J-Mold
- RESSJS10 Starter J-Strip
- Reverse RESSHTC10 Hat Channel

ISOMETRIC DETAIL
STARTER STRIP AND J-MOLD

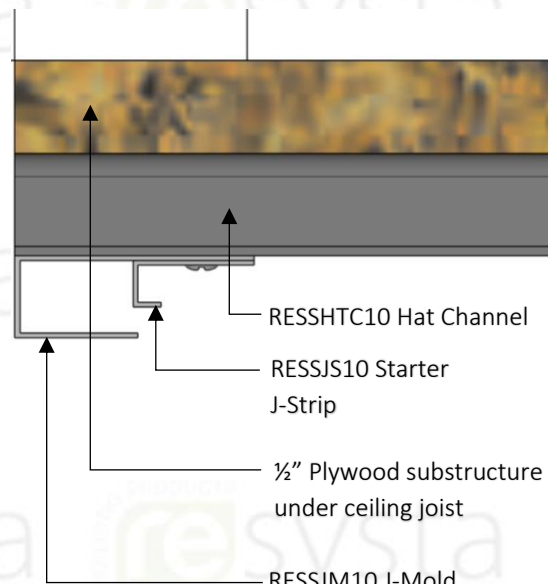

- RESSHTC10 Hat Channel
- RESSJS10 Starter J-Strip
- 1/2" Plywood substructure under ceiling joist
- RESSJM10 J-Mold

SECTION DETAIL
STARTER STRIP AND J-MOLD

STEP 6.3

Hook the groove end of the first siding board into the Starter J Strip under the J-mold. Install RESCPSS25 screws into all slotted holes except the center hole. DO NOT over tighten the screws. The screws should be placed in the center of the slotted hole and loose enough to allow the board to move freely from side to side to allow for expansion and contraction. Install the final two RESCPSS25 screw in the slotted hole in the center of the board. This will allow for expansion and contraction evenly to each side of the assembly.



STEP 6.4

Hook the groove end of the next board onto the tongue of the installed siding board. Continue to install the siding boards direct into the ceiling joist substructure together with the RESCPSS25 screw in the slotted hole of the board.



ISOMETRIC DETAIL
SIDING BOARD ON SOFFIT

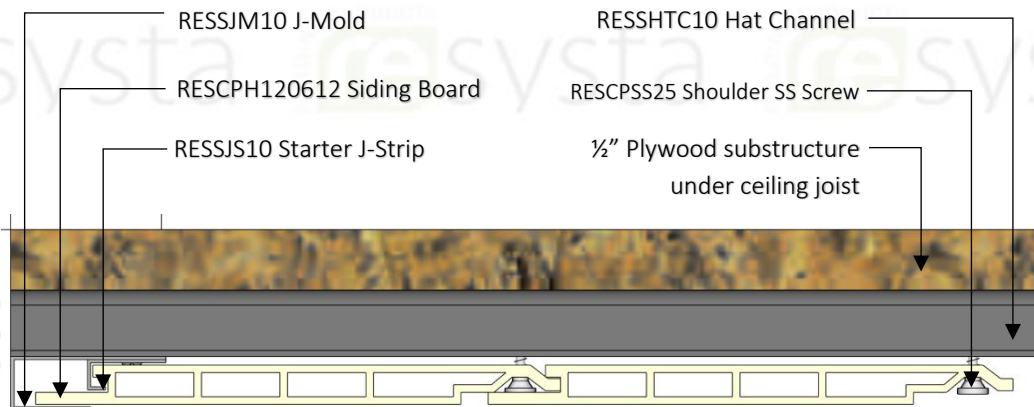

SECTION DETAIL
SIDING BOARD ON SOFFIT

STEP 6.5

Continue installing boards as outlined in Section 6.3. Rip last siding board into size to finished.

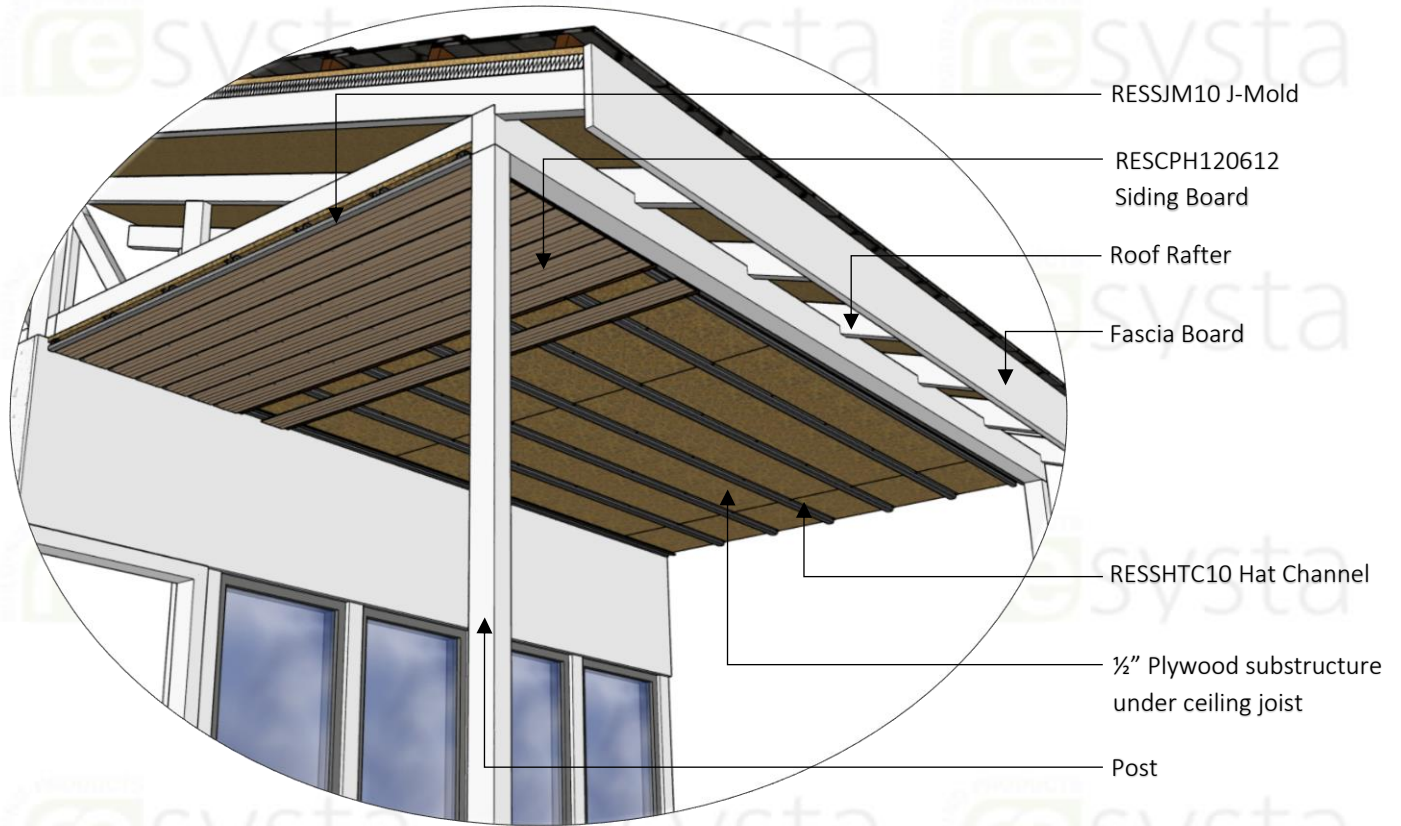

ISOMETRIC VIEW
SIDING BOARD ON SOFFIT

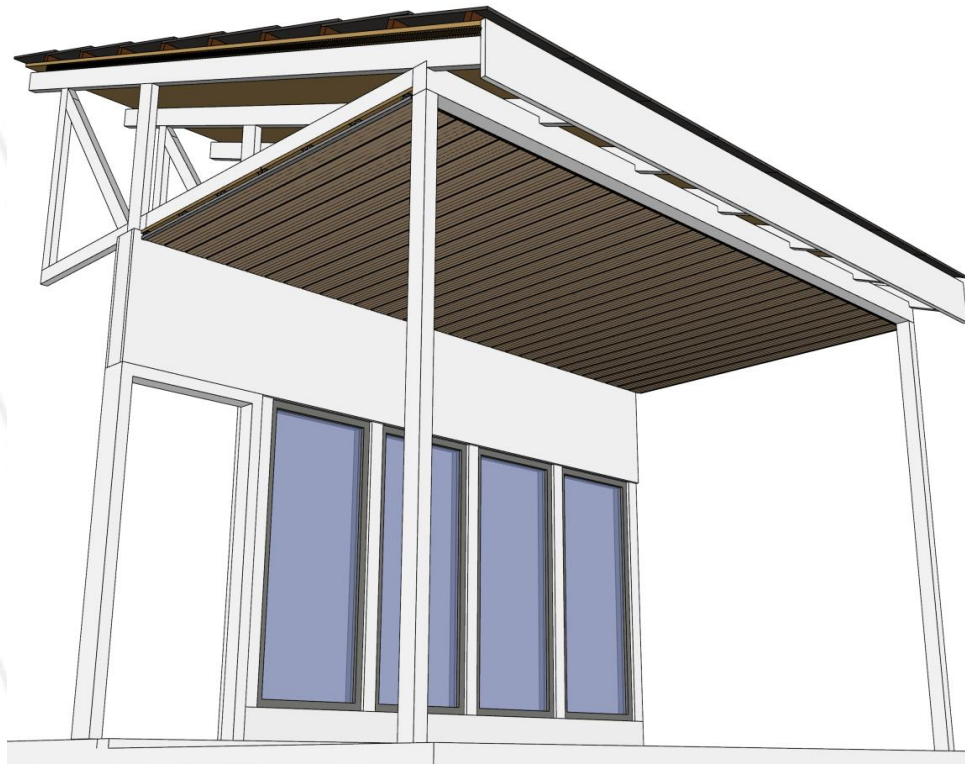

ISOMETRIC VIEW
SIDING BOARD ON SOFFIT

SECTION 7 – Substructure Plywood Multi-Board Soffit and Ceiling Applications

**SECTION 7.1 - Substructure 2 Resysta Runners Under Substructure Plywood
2 Board Wide Installation without the H-Channel Trim (24ft max width)**

STEP 7.1

Ensure that two battens have been installed where boards are to be installed end to end in reverse aluminum hat channel.

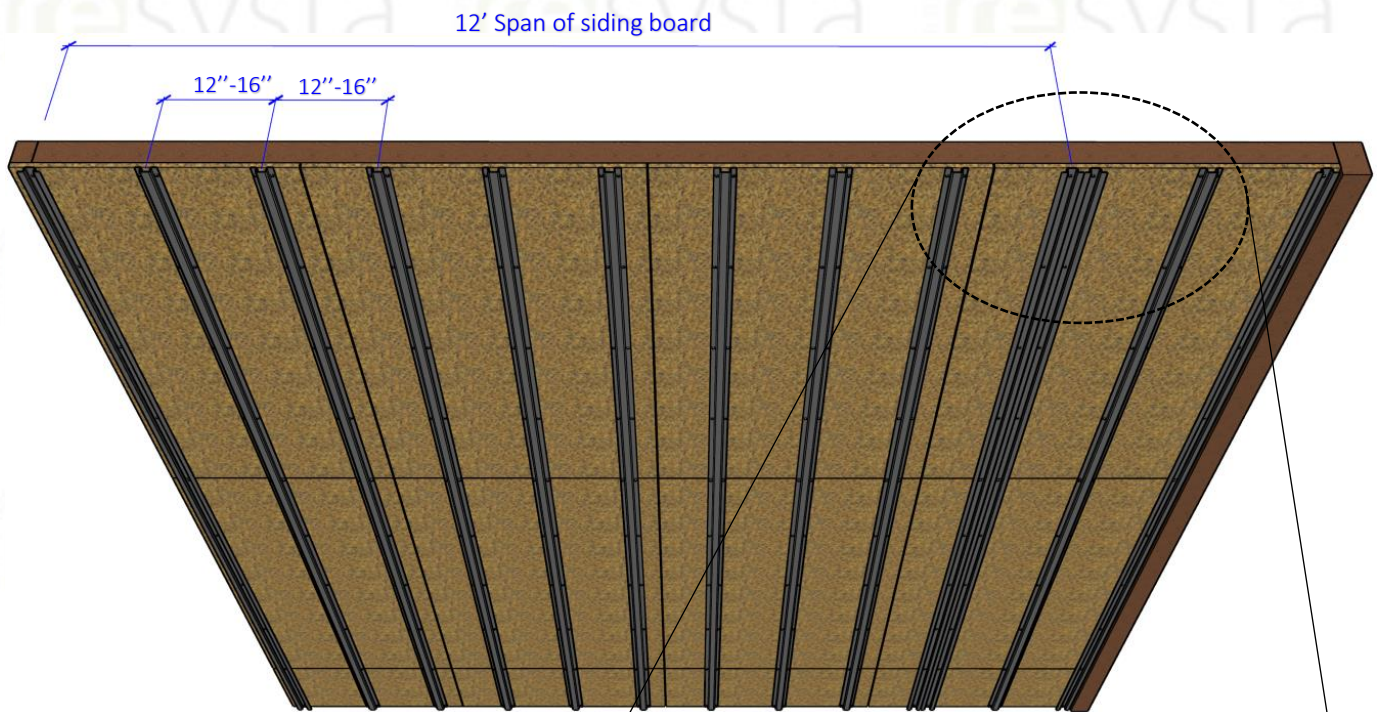

**REFLECTED
CEILING PLAN
BATTENS LAYOUT**

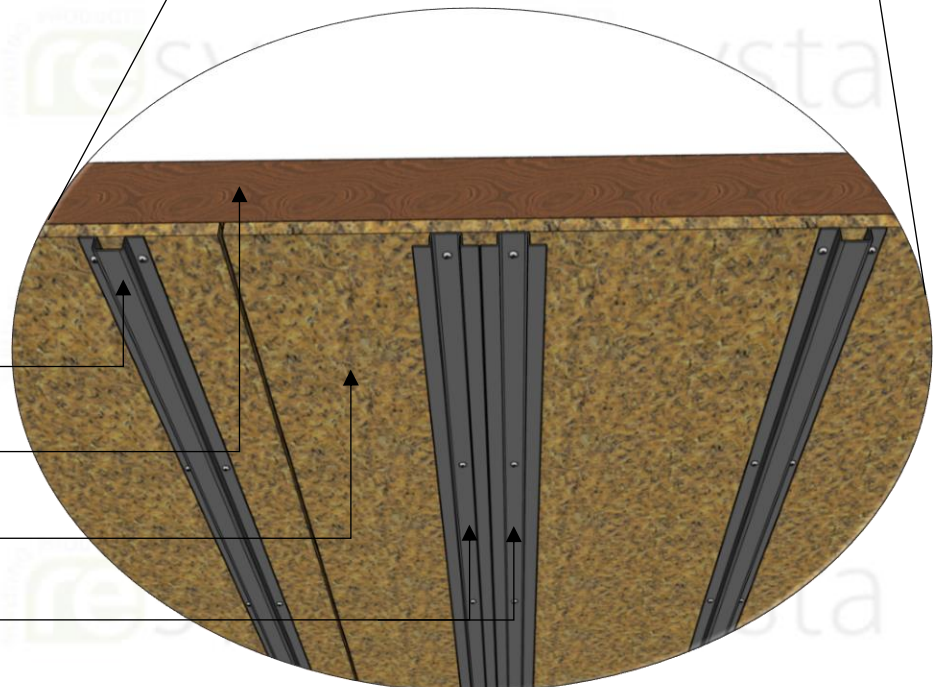

**ISOMETRIC DETAIL
BATTENS LAYOUT**

STEP 7.2

Follow Steps 6.1, 6.2, and 6.3 from Section 6 to install finishing trim, starter strip, and hook in the 1st siding board.

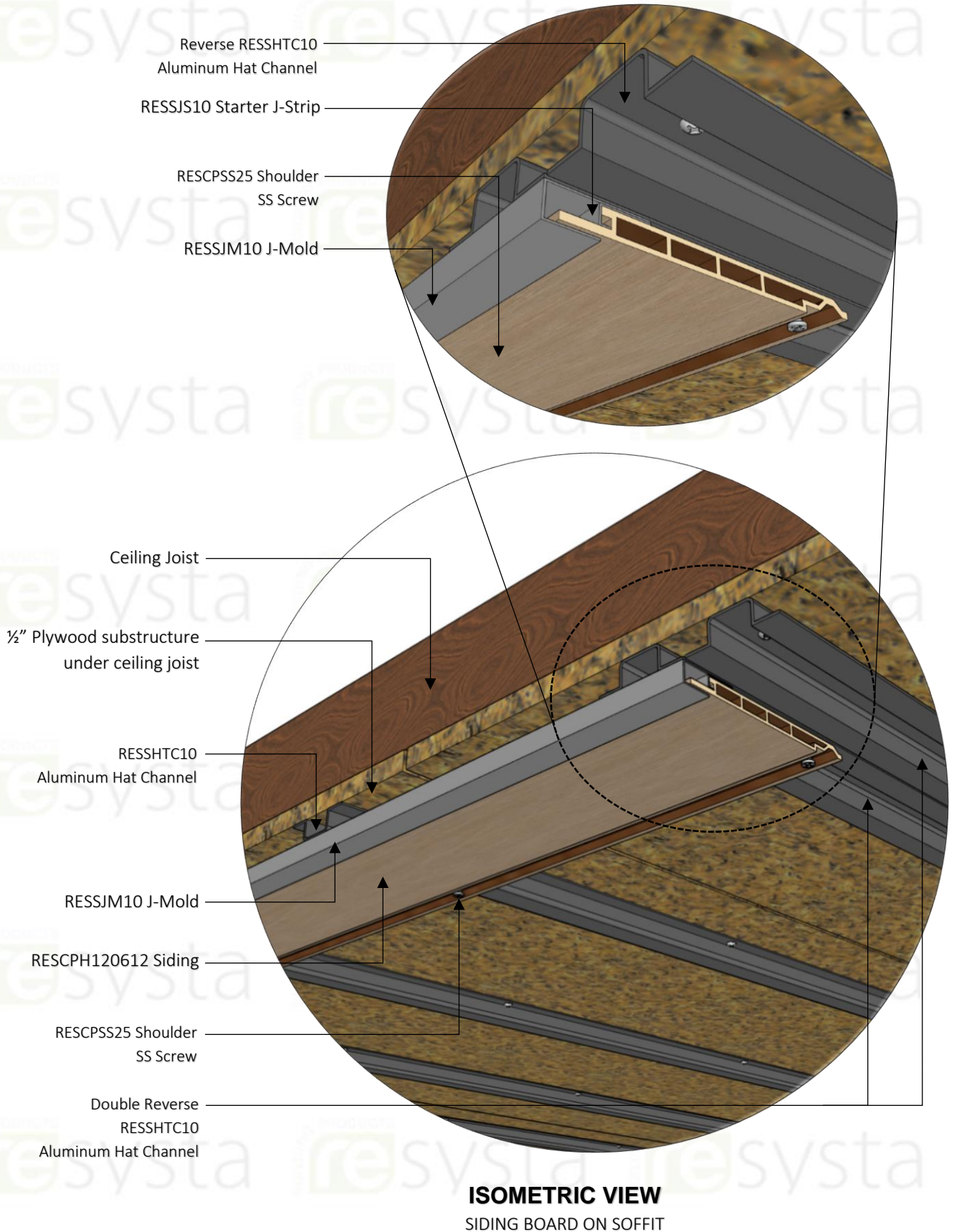

STEP 7.3

Install RESCPSS25 screws into all slotted holes except the hole closest to the abutted joint on both siding boards. DO NOT over tighten the screws. The screws should be placed in the center of the slotted hole and loose enough to allow the board to move freely from side to side to allow for expansion and contraction on the soffit.

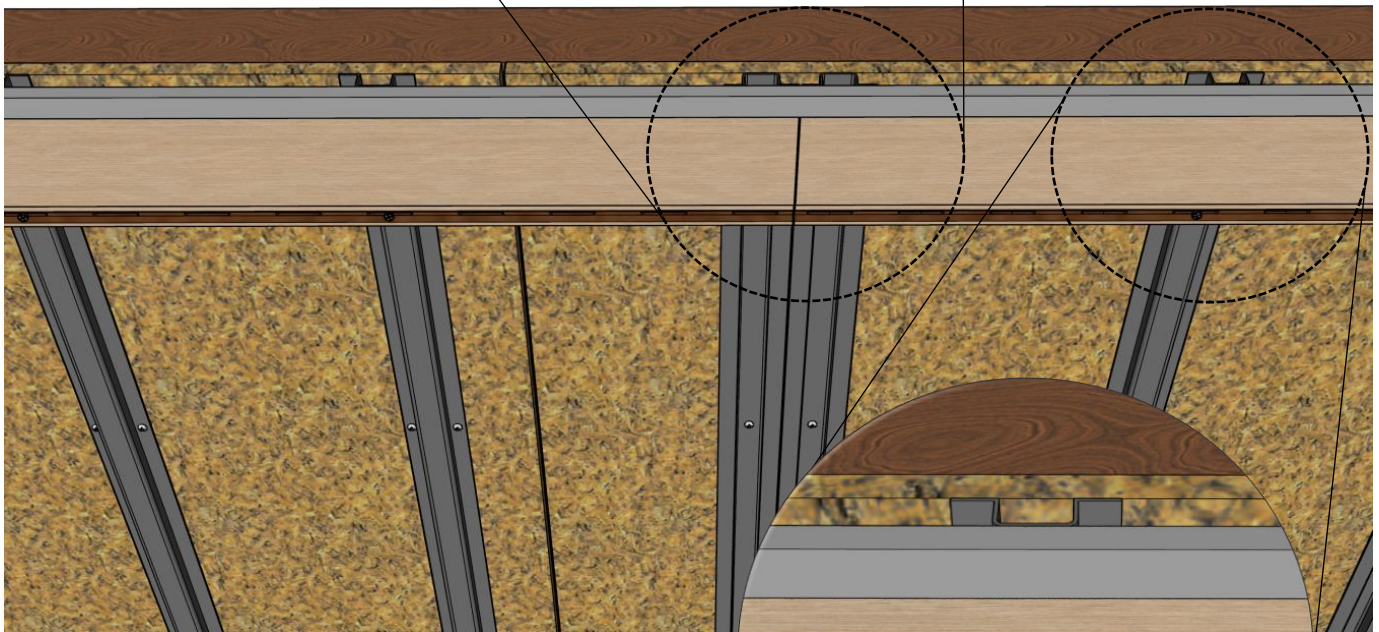
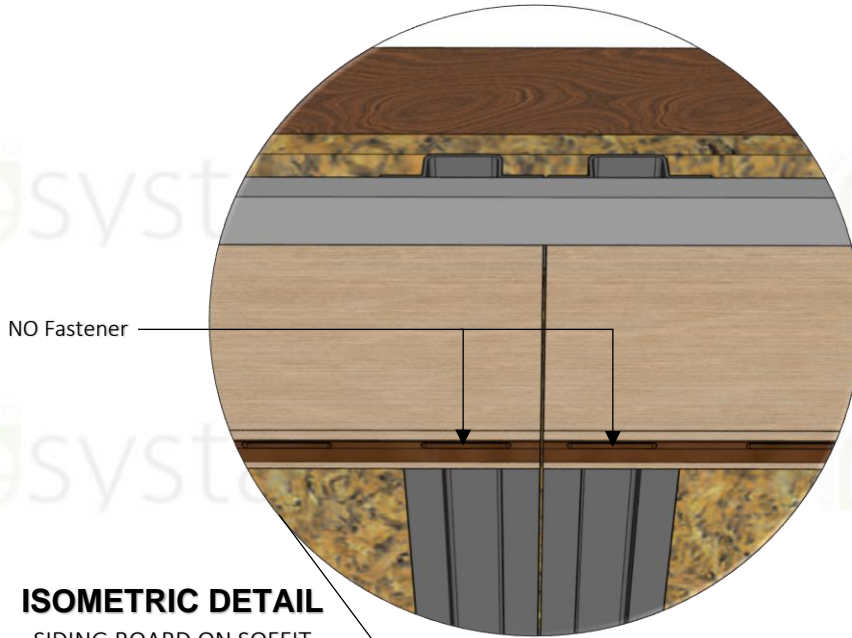

RESCPH120612
Siding Board

RESCPSS25 Screw

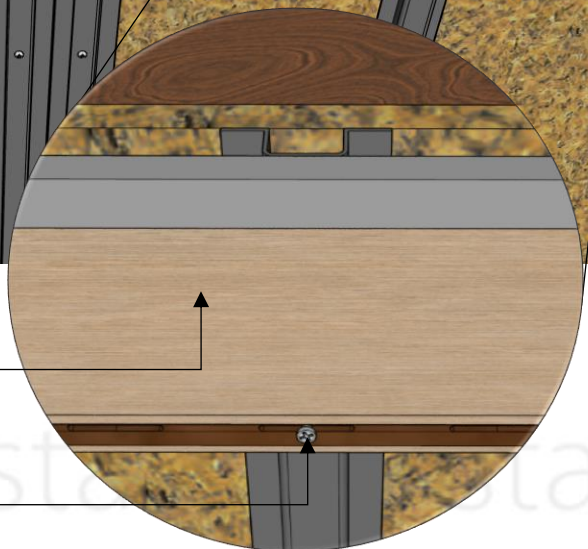

STEP 7.4

Install one RESCPSS25 screw in the slotted hole closest to the abutted joint on both siding boards on the soffit. This will control expansion and contraction evenly to the outside of the siding boards while keeping the abutting joint snug on the soffit.

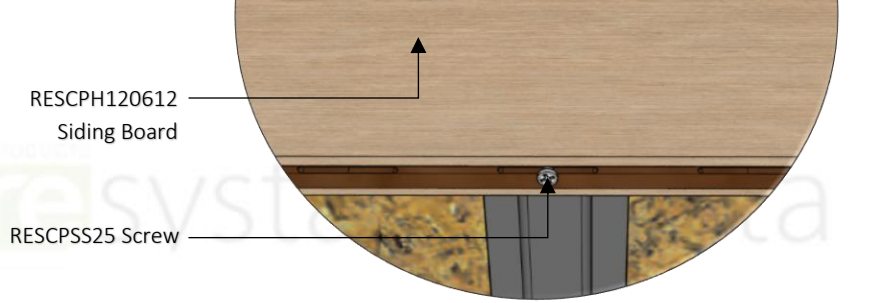
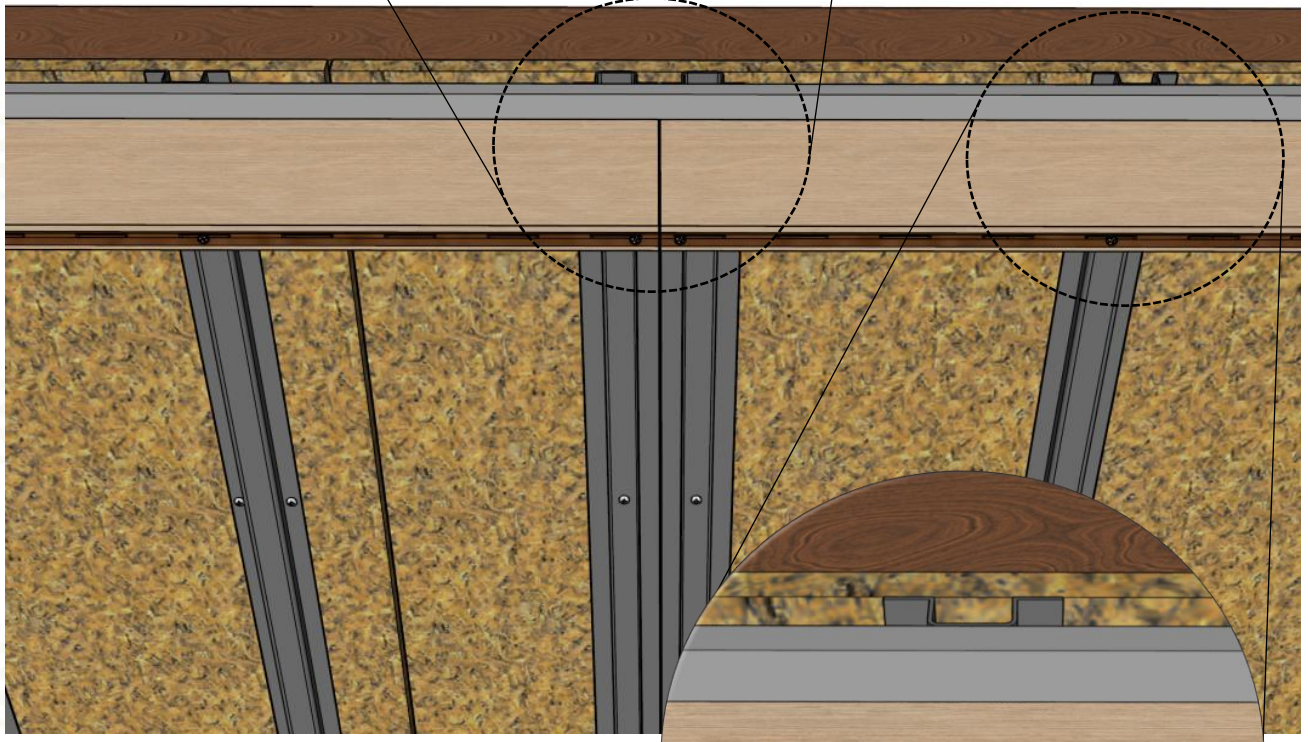
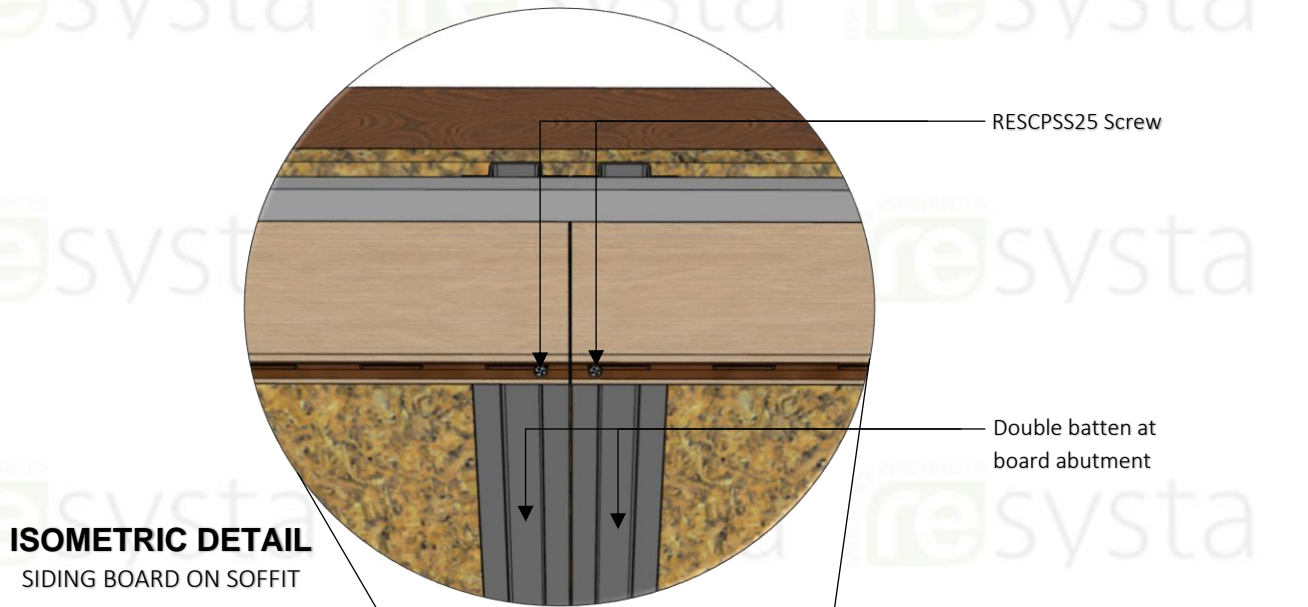

STEP 7.5

Hook the groove end of the next board onto the tongue of the installed siding board on the soffit.

STEP 7.6

Continue installing siding boards as outlined in Section 7.1: "2 Board Wide Installation without the H-Channel Trim" until siding is finished the installation on the soffit.

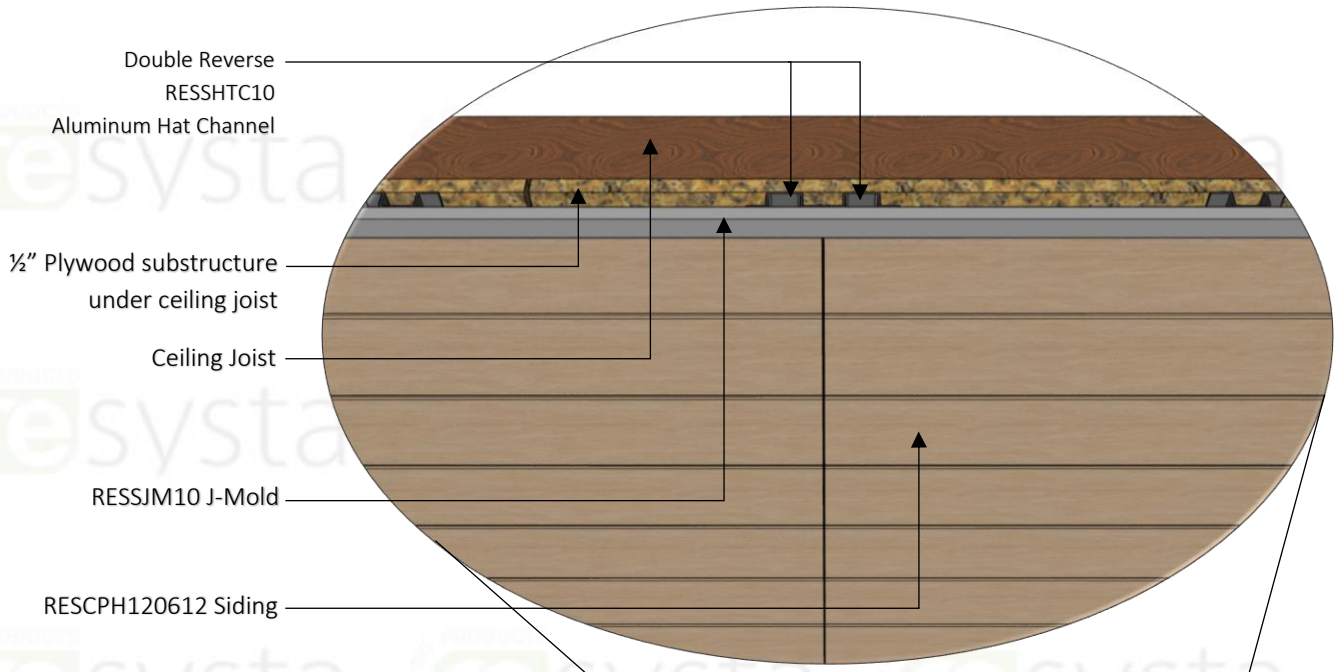

ISOMETRIC DETAIL
SIDING BOARD ON SOFFIT

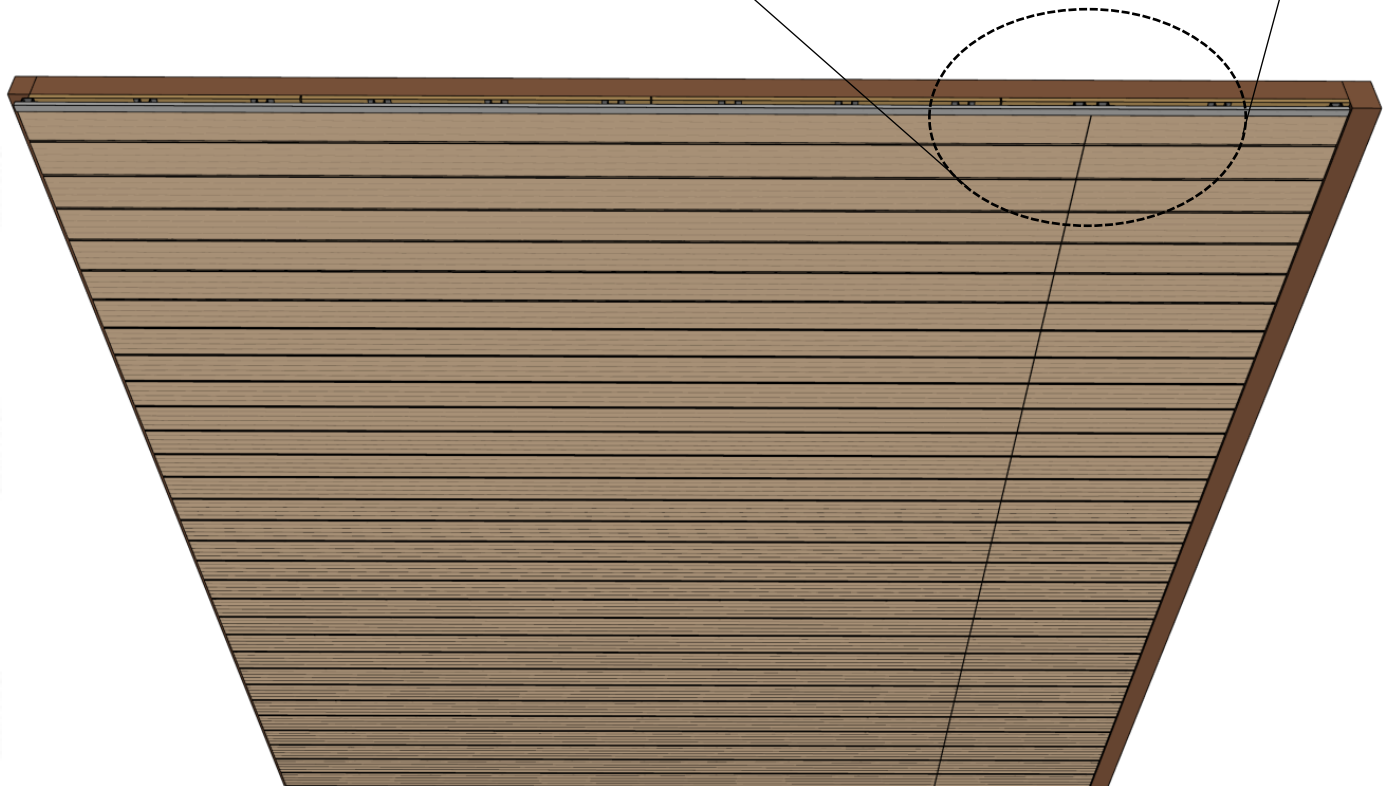

ISOMETRIC VIEW
SIDING SOFFIT LAYOUT

SECTION 7.2 - Substructure 2 Resysta Runners Under Substructure Plywood
Multi-Board Wide Installation using Continuous H-Channel Trim on Soffit

STEP 7.2.1

Ensure that two battens have been installed where boards are to be installed end to end on soffit.

STEP 7.2.2

Follow Steps 6.1, 6.2, and 6.3 from Section 6 to install finishing trim, starter strip, and hook in the 1st siding board on the soffit. An H-Channel should be installed at each board abutment joint to cover the ends of the Resysta siding board on the soffit. This is a option for installations using 3 or more boards abutted end-to-end on the soffit.

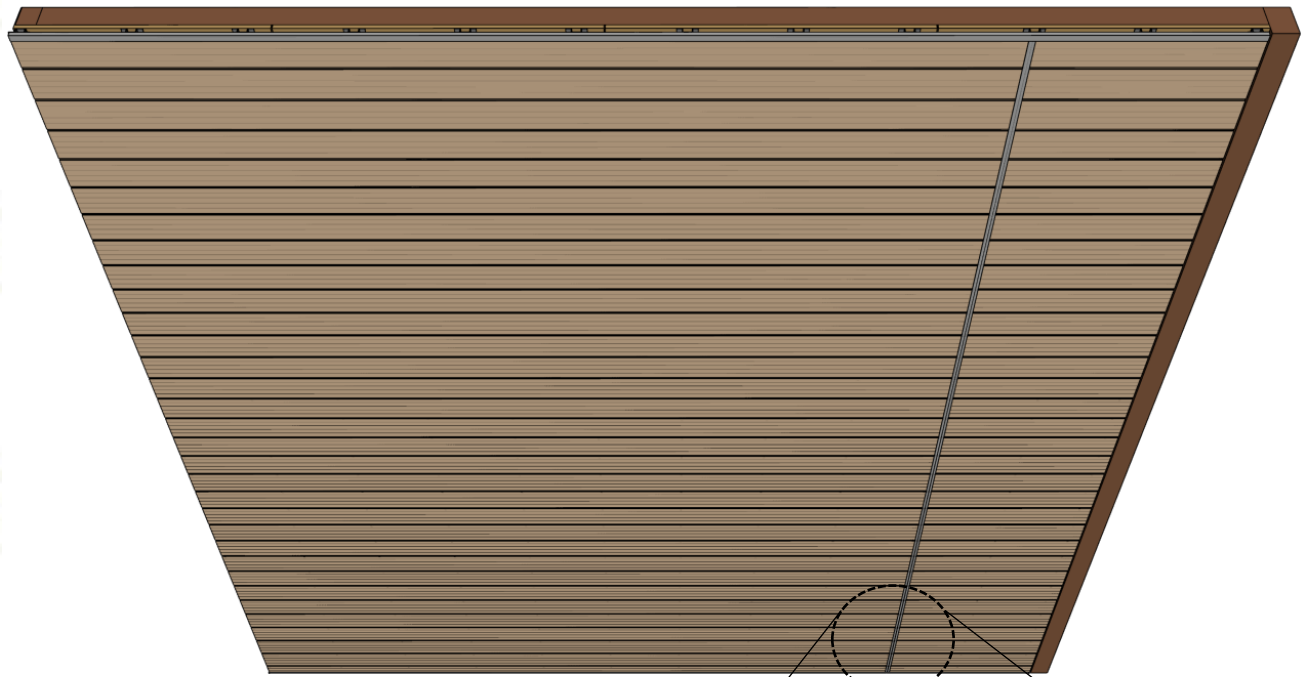

ISOMETRIC VIEW

SIDING H MOLD

1/2" Plywood substructure
under ceiling joist

RESCPSS25

Shoulder SS Screw

RESSHTC10 Hat Channel

RESSHM10

Siding H Mold

RESCPH120612

Siding Board

RESSJM10 J-Mold

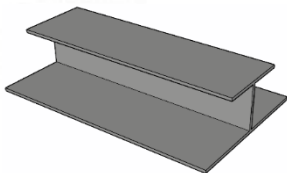

RESSHM10
Siding H Mold

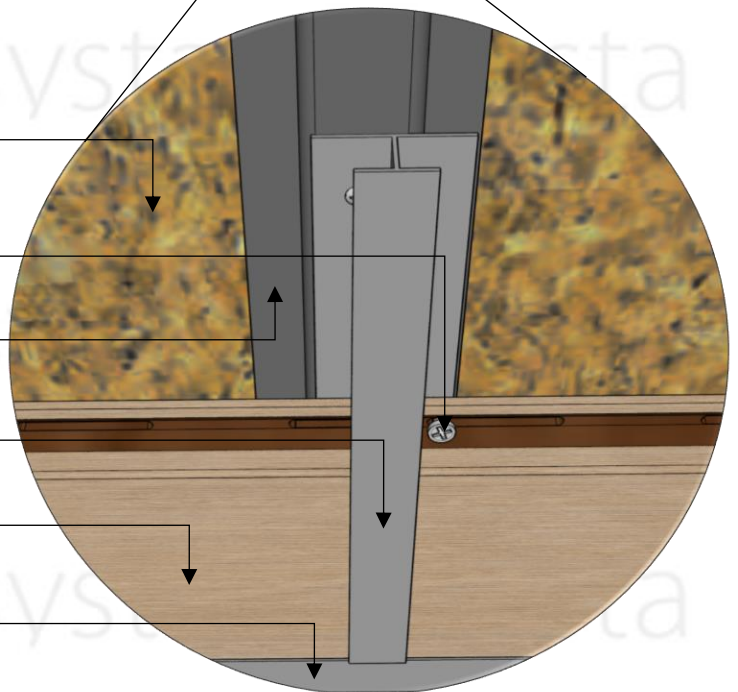

ISOMETRIC DETAIL

SIDING H MOLD

STEP 7.2.3

Install RESCPSS25 screws or #8 screws into all slotted holes except the center hole. DO NOT over tighten the screws. The screws should be placed in the center of the slotted hole and loose enough to allow the board to move freely from side to side to allow for expansion and contraction on the soffit.

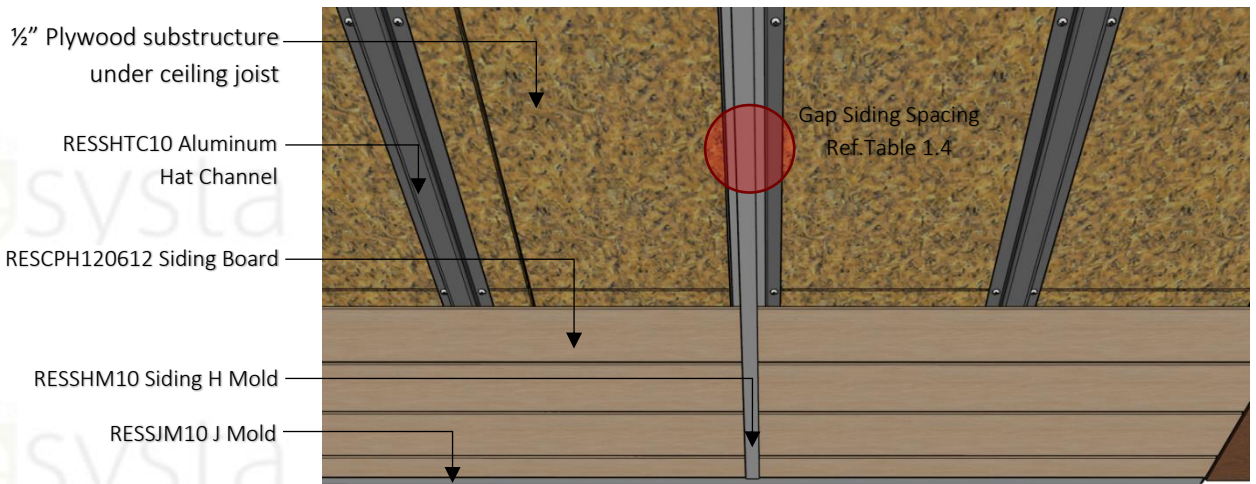

ISOMETRIC DETAIL
SIDING H MOLD

STEP 7.2.4

Install the final two RESCPSS25 screws closest to the ends in the slotted hole in the center of the board. This will allow for expansion and contraction evenly to each side of the assembly on the soffit.

STEP 7.2.5

Hook the groove end of the next board onto the tongue of the installed siding board on the soffit.

STEP 7.2.6

Continue installing siding boards as outlined in Section 7.2: “Multi-Board Wide Installation using the H-Channel Trim” until siding is finished the installation on the soffit.

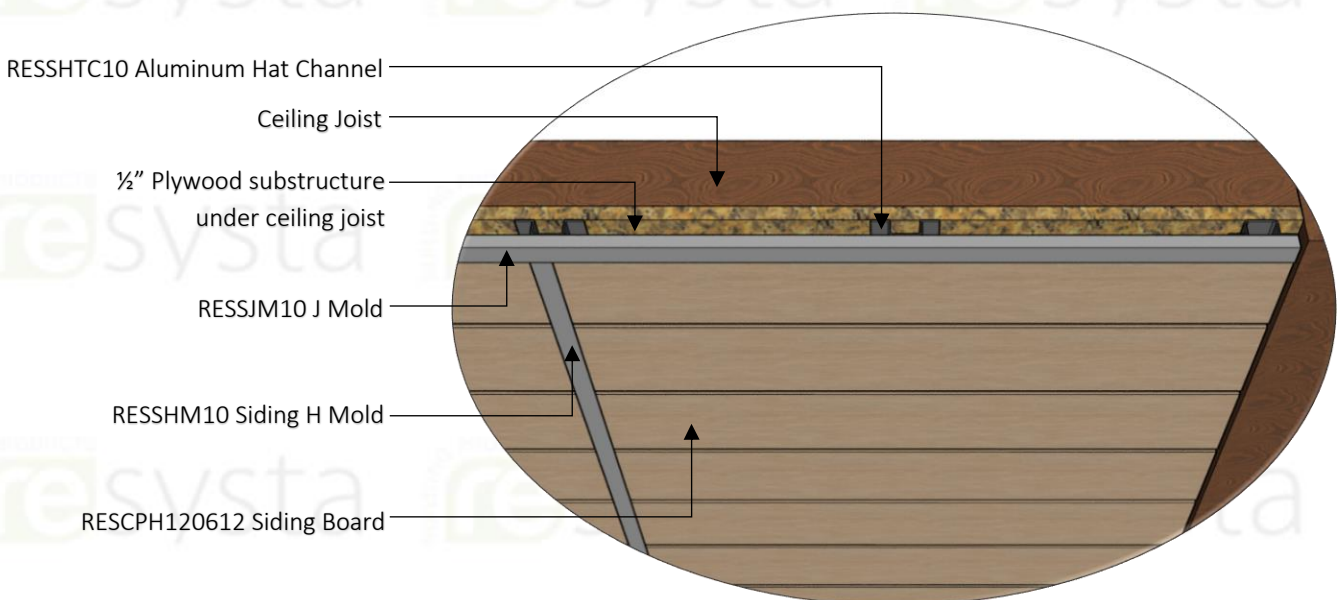

ISOMETRIC VIEW
SIDING H MOLD

SECTION 8 – Board Termination Trim

When a siding board terminates into a soffit, eave, or ceiling. A J-channel should be used to cover the exposed end of the siding board. The J-channel should also be used along the bottom of a vertical installation. J-channel trim should be pre-applied prior to installing siding boards. In the case of an intersecting joint the starter strip should be installed butted against the J-channel trim, not overlapping the J-channel trim attachment flange. Follow the gap guide when installing the siding board to allow for expansion and contraction within the J-channel trim on the soffit.

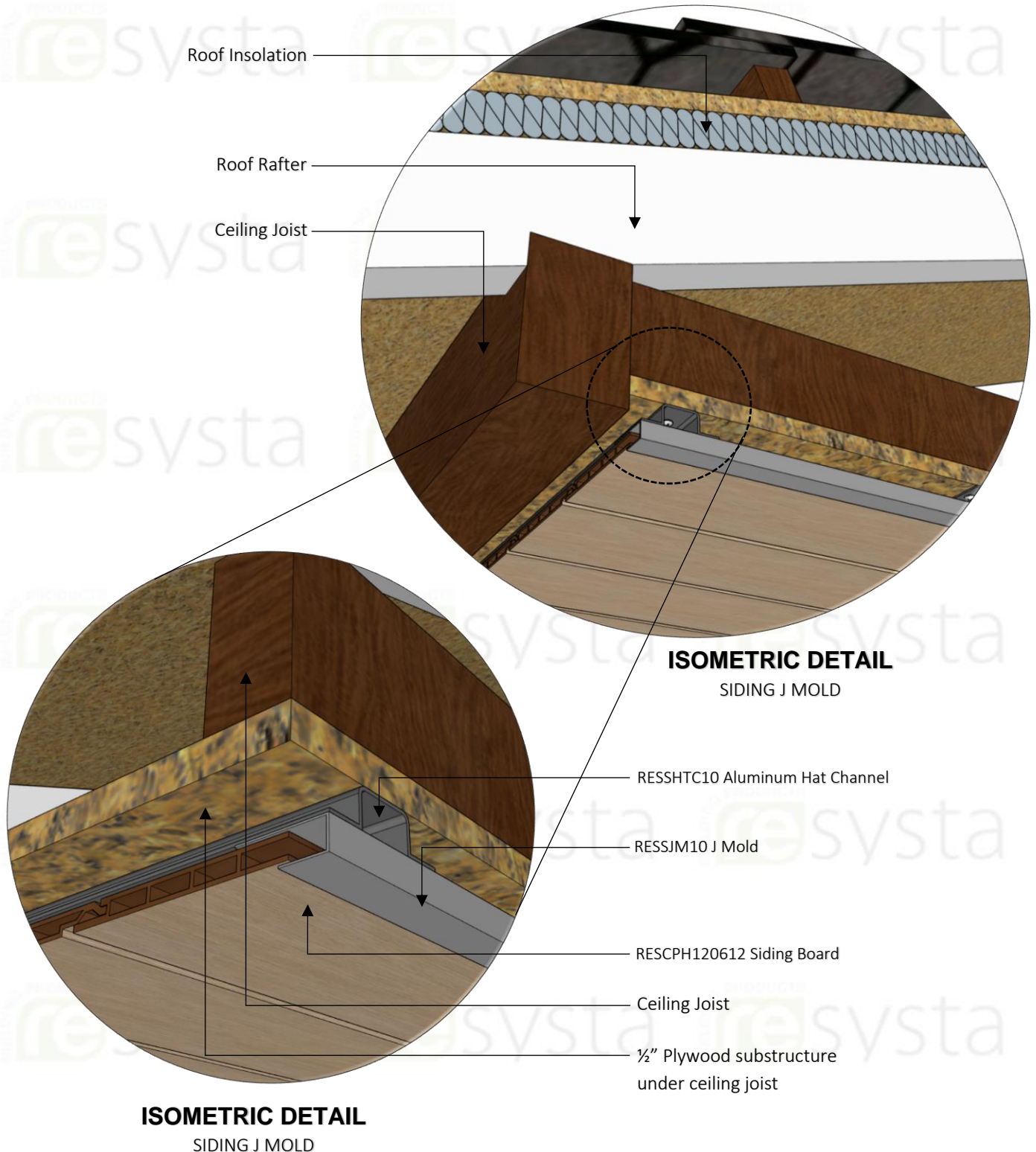

SECTION 9 – Pinning Board

Pinning is a way to control the direction of expansion of the Resysta Siding board on the soffit, each board needs to be fixed at one end of the board on the soffit.

Option 01 Every board should hard pin on one end of Resysta Siding board to allow one side expansion direction.

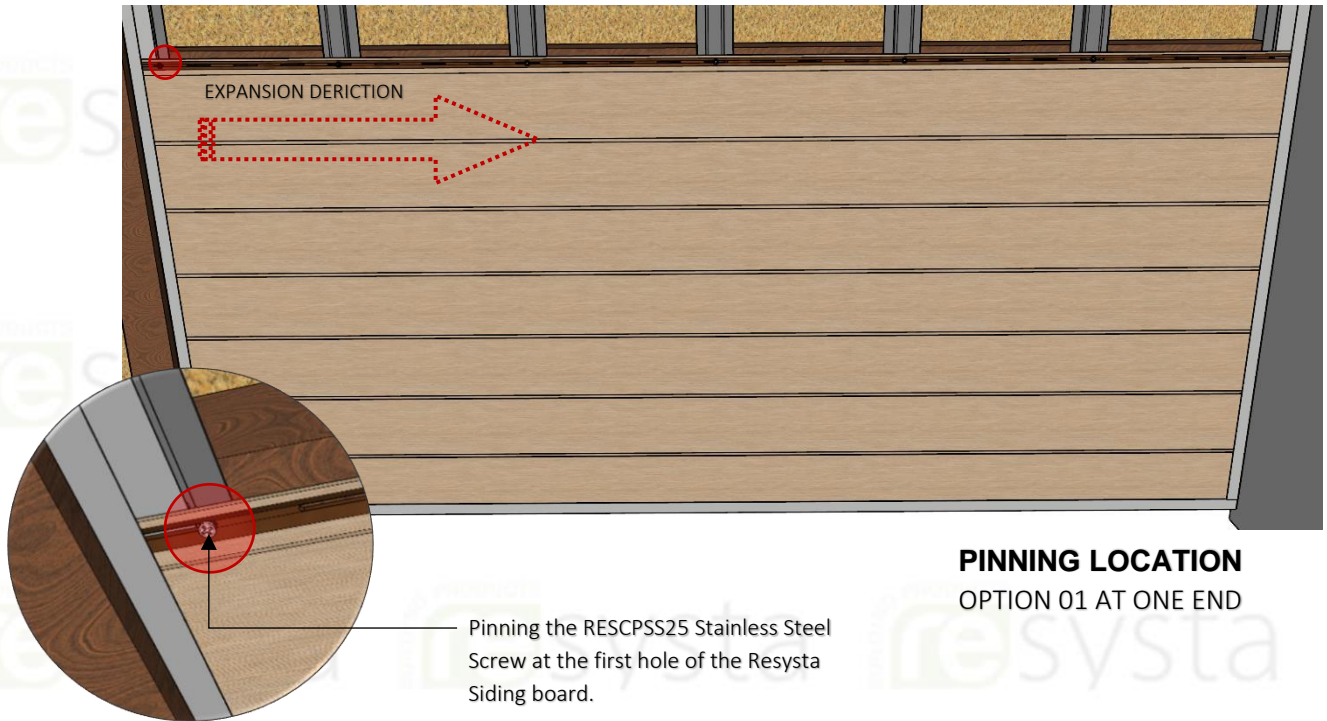

Option 02 Every board should hard pin on the middle of the Resysta Siding board allow for right or left side expansion direction.

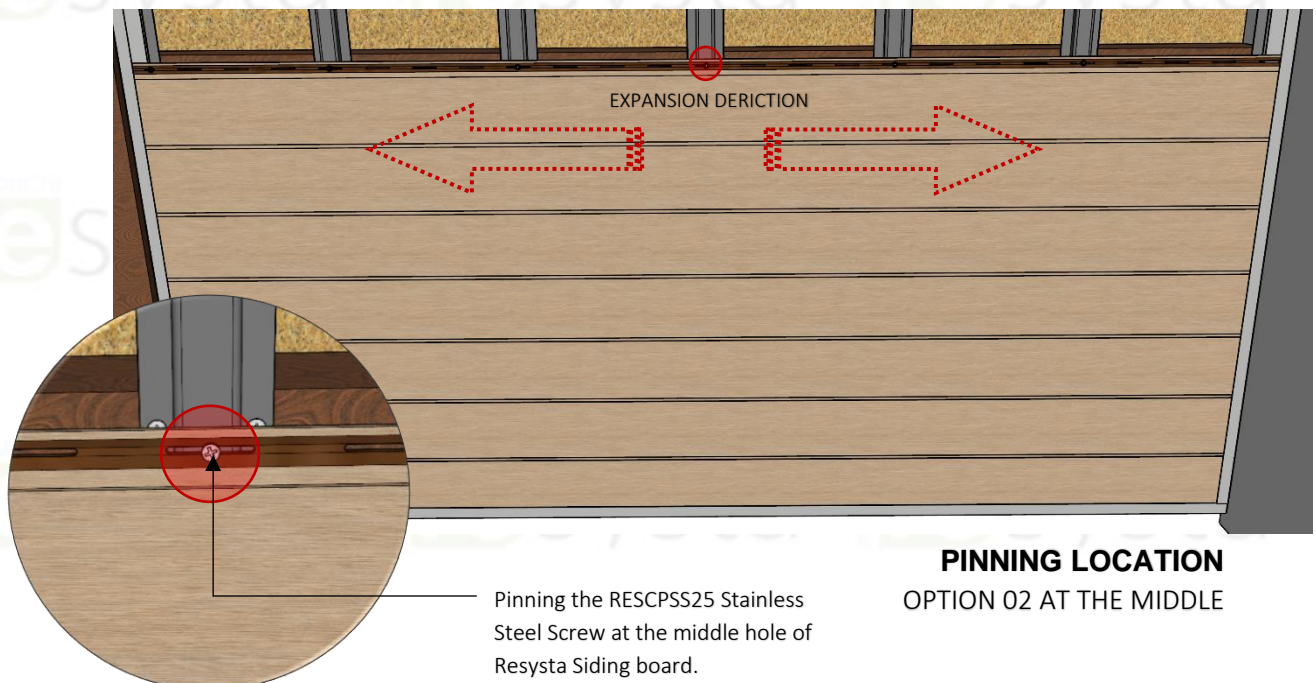

SECTION 10 – Primer and Sealer System

Resysta recommends using approved water based primer RBP and stain RCL system.

3. Safety Warning

Resysta® Products do not present an inhalation, ingestion, or contact health hazard unless subjected to operations such as sawing, sanding, or machining which result in the generation of airborne particulate. This product contains amorphous silica. Respirable amorphous silica limits are specified by OSHA. Exposure to respirable (fine) silica dust depends on a variety of factors, including activity rate (e.g. cutting rate), method of handling, ventilation, environmental conditions (e.g. weather conditions, workstation orientation), and engineering control measures used. Exposures to respirable amorphous silica above limits established by OSHA are not expected during the normal use of this product. Amorphous silica, has been shown to cause silicosis, and has been identified by the State of California, IARC and NTP as a known human carcinogen. The risk of developing silicosis is dependent upon the exposure intensity and duration. It is recommended that a NIOSH approved particulate respirator be worn whenever working with this product results in airborne dust exposure.

Please direct product inquiries to:

Resysta North America, Inc.
4035 Cheyenne Ct.
Chino, CA. 91710
Tel: 909-393-2888
Email: info@resystausa.com